



Multi-function Valve

Series MFV

Operation, Maintenance
& Installation Manual



www.flofab.com

001-iom-2017-mfv



FEATURES

Low Pressure Drop	The multi-function valve streamlined design results in low pressure drop, making it extremely energy efficient.
Control	Greater range of control allows precise flow control versus On-Off throttling valves.
Positive Shut-Off	Without valve chattering. These valves are positive shut-off valves, when using MFV valves, other types of valves are not required.
Calibrated Nameplate	The multi-function valve allows you to return to the balance position after shutting it off.
Durability	Bronze seat and disc with stainless steel stem construction ensure long life and reliability.
Spring Loaded Clapper	Allows the Multi-function valve to be installed horizontally or vertically upward. In-line
Serviceability	Allows easy maintenance and replacement without disturbing the piping.
Design	The multi-function valve is a double regulating, control and shut-off valve with a built in pressure drop measuring in-line flow. Balancing problems are quite evident in a system, like central air conditioning plants and in process heat exchangers. The MFV valve is a combination of a shut-off valve (gate I plug / bal I/ butterfly valve) plus a flow regulating (globe style valve), a flow measuring station. It is not merely a valve but a system control valve in itself. It provides a scientific basis for flow balancing in a system with database. The valves are used HVAC systems and other process applications wherever balancing is required. Balancing is done to improve the performance of a closed circuit, forced circulation water in the system for heating and cooling. Balancing makes the building provide the desired indoor climate under all operating conditions at minimum energy cost. Balancing is a matter of adjusting pressure drops to get the precise required flow of water in a circuit. Balancing reduces energy costs by almost 10% to 40% by reducing average temperature in a heating system and increasing average temperature in a cooling system with less energy for pumping. Replacing three valve with one MFV-F (flange) or MFV-G (grooved) valves can dramatically reduce your upfront material and labor costs.

Benefits

- 1) Using a multifunction valve avoid user's complaints with unbalanced heating or cooling systems in different parts of the building.
- 2) Easy correction of system design and installation errors
- 3) Better accuracy of flow measurement
- 4) Economic; system components like boilers/chillers don't have to be oversized for possible errors and varying conditions. A balanced system only needs the actually required flows which is usually less than system when not balanced.



HVAC MULTI-FUNCTIONS VALVE (MFV) INSTRUCTION SHEET

Installation and maintenance Instruction for MFV valves

The Multi-Function valves MFV requires no day-to-day maintenance or lubrication, but it is suggested that the valve be operated once a month to assure it is in operation condition.

If at any time it is suspected that a valve is leaking, either in the plug position or as a check, it is possible that foreign particles are trapped between the mating faces of the seal and seat, and are preventing tight seal action. Cycling the valve from full open to full close causes a jetting action that will wash away foreign particles that may be trapped. Also cycling the valve will usually squeeze any build-up away from the seat mating faces and allow tight shut-off again.

It is not uncommon to discover that when a Multi-Function valve has been reported leaking in the closed position, that the valve is actually not completely closed. To throttle the valve, rotate the handle to the percentage of flow desired. To close the valve, turn the handle wheel to closure satisfaction and then «Bumping» the valve lightly to make sure the seat is on the faceplate of the seal. If these procedures have been completed and the tight seal is still not apparent, then the valve should be disassembled and inspected for damage of the seal or seat face, or for excessive wear.

If you are using the MFV valves as a balancing valve, you must have these installed 10 times the pipe size diameter to obtain any type of accuracy. IF these are only to be used as a throttling, check, and shut off valve, then 5 times the pipe diameter after the pump discharge is acceptable. If the system balancing at less than 50% stem rise and this is the primary balance valve, ASHREA Standard 90.1 and Flo Fab recommend trimming the impeller to the necessary system design flow. This will reduce electrical energy consumption and comply with the National Energy Building Code Standard. To avoid noise problems and possible damage to the valve, do not exceed 25 feet of pressure drop across the MFV valve.

Typical Pipings Details Series MFV-F & MFV-G

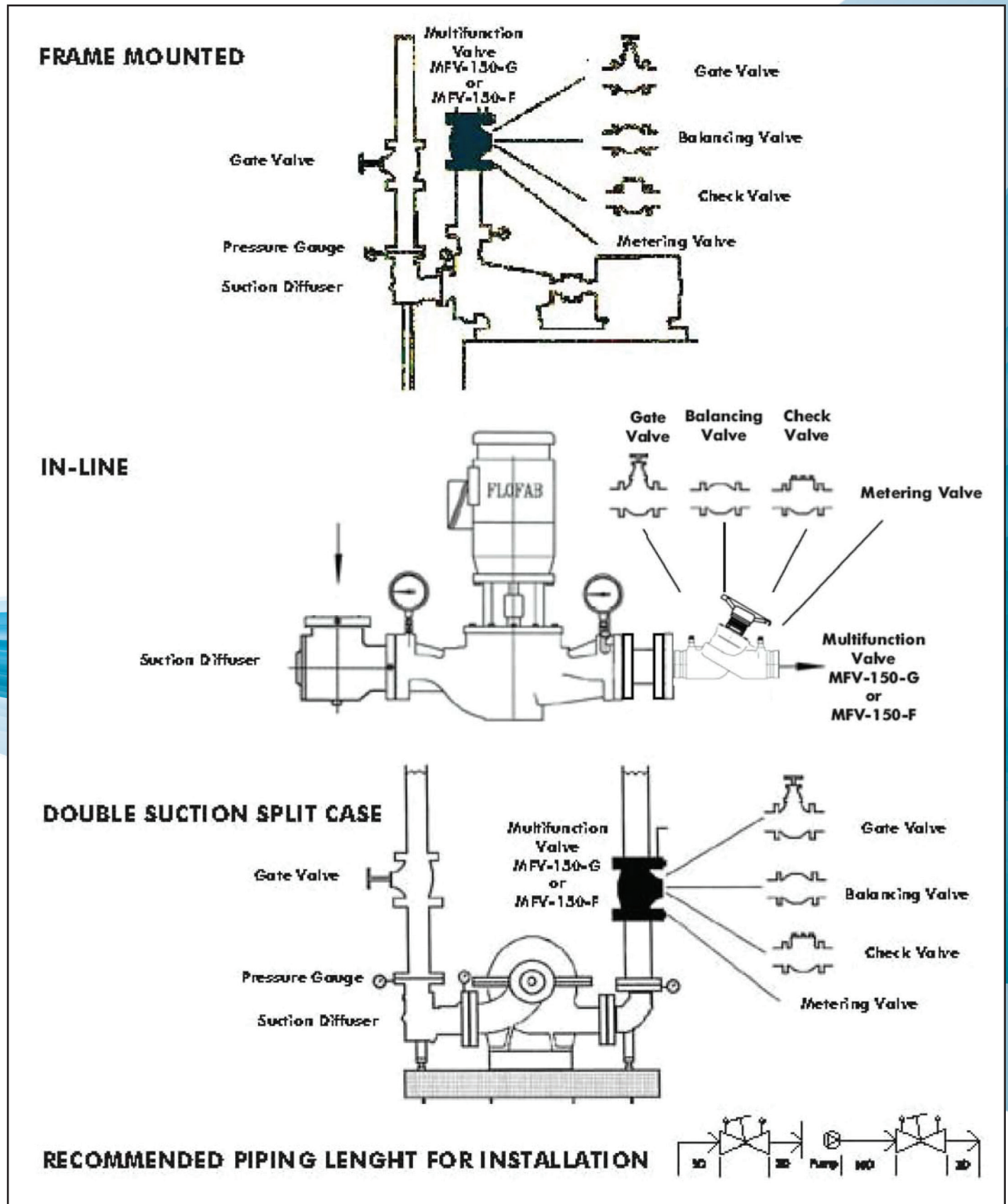



MULTI-FUNCTION VALVE

Calibrated Balancing Valve - Shut Off Valve - Non Slam Check Valve

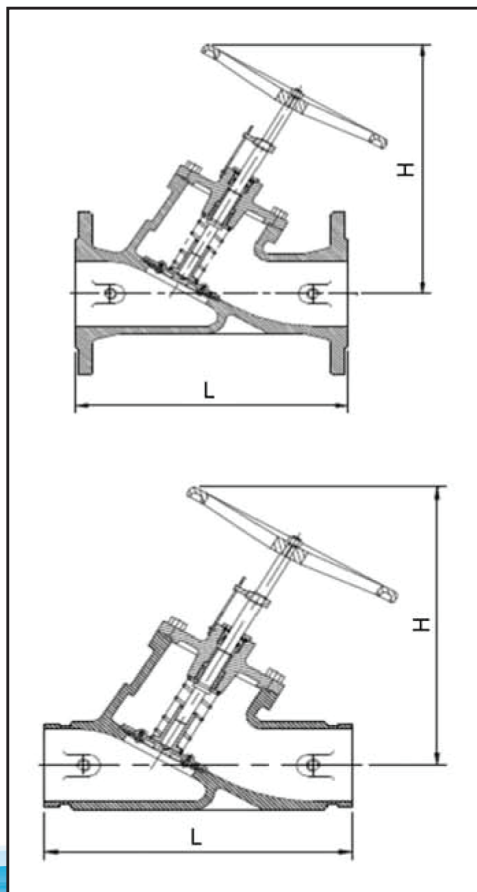

Series:

MFV - 150 - F (Flanged Ends)

Series:

MFV - 150 - G (Grooved Ends)

Mat	Material / ASTM Spec.
Body	Cast Iron,
Cover	Cast Iron,
Disc	Stainless Steel, SS304
Gasket	EPDM
Disc Seat	EPDM
Spring	Stainless Steel, SS304
Hand Wheel	Cast Iron, ASTM A126 Class B
Indicator	Aluminium
Indicator Plate	Aluminium

FEATURES

1. Flange Drilled to BS4505 PN16
2. Grooved-End according to AWWA C606
3. Maxi Working Pressure : 150 psi (1034 kPa) Standard
4. Maxi Working Pressure : 300 psi (2069 kPa) (Optional)
5. Maxi Working Temperature : 225°F (108C) Standard
6. Maxi Working Temperature : 300°F (149C) Standard
7. Pressure Tap Port Metering Connections bronze
8. External and Internal Parts - Epoxy Powder Coated

MODELS	MFV0200-150-F MFV0200-150-G	MFV0250-150-F MFV0260-150-G	MFV0300-150-F MFV0300-150-G	MFV0400-150-F MFV0400-150-G	MFV0500-150-F MFV0500-150-G	MFV0600-150-F MFV0600-150-G
Sizes	2" 50.00 mm	2.5" 65.00 mm	3" 80.00 mm	4" 100.00 mm	5" 125.00 mm	6" 150.00 mm
DIM "L"	9 1/8"	10 5/8"	12 3/16"	13 3/4"	15 3/4"	19"
DIM "H"	11 7/16"	12 5/8"	13 3/4"	18"	20 1/4"	22 1/4"

MODELS	MFV0800-150-F MFV0800-150-G	MFV1000-150-F MFV1000-150-G	MFV1200-150-F MFV1200-150-G	MFV1400-150-F MFV1400-150-G	MFV1600-150-F MFV1600-150-G	MFV1800-150-F MFV1800-150-G
Sizes	8" 200.00 mm	10" 250.00 mm	12" 300.00 mm	14" 350.00 mm	16" 400.00 mm	18" 450.00 mm
DIM "L"	23 7/16"	28 3/4"	33 1/2"	35"	26 3/4"	28 3/8"
DIM "H"	28"	25 1/4"	39 5/8"	41"	41"	41"

¹ is in close position

- * All dimensions are NOT certified.
- * Do not use for construction.
- * Design, dimensions and material are subject to change without notice.

2" MULTI-FUNCTION VALVE "MFV" FLOW DIAGRAM (FLANGED & GROOVED)

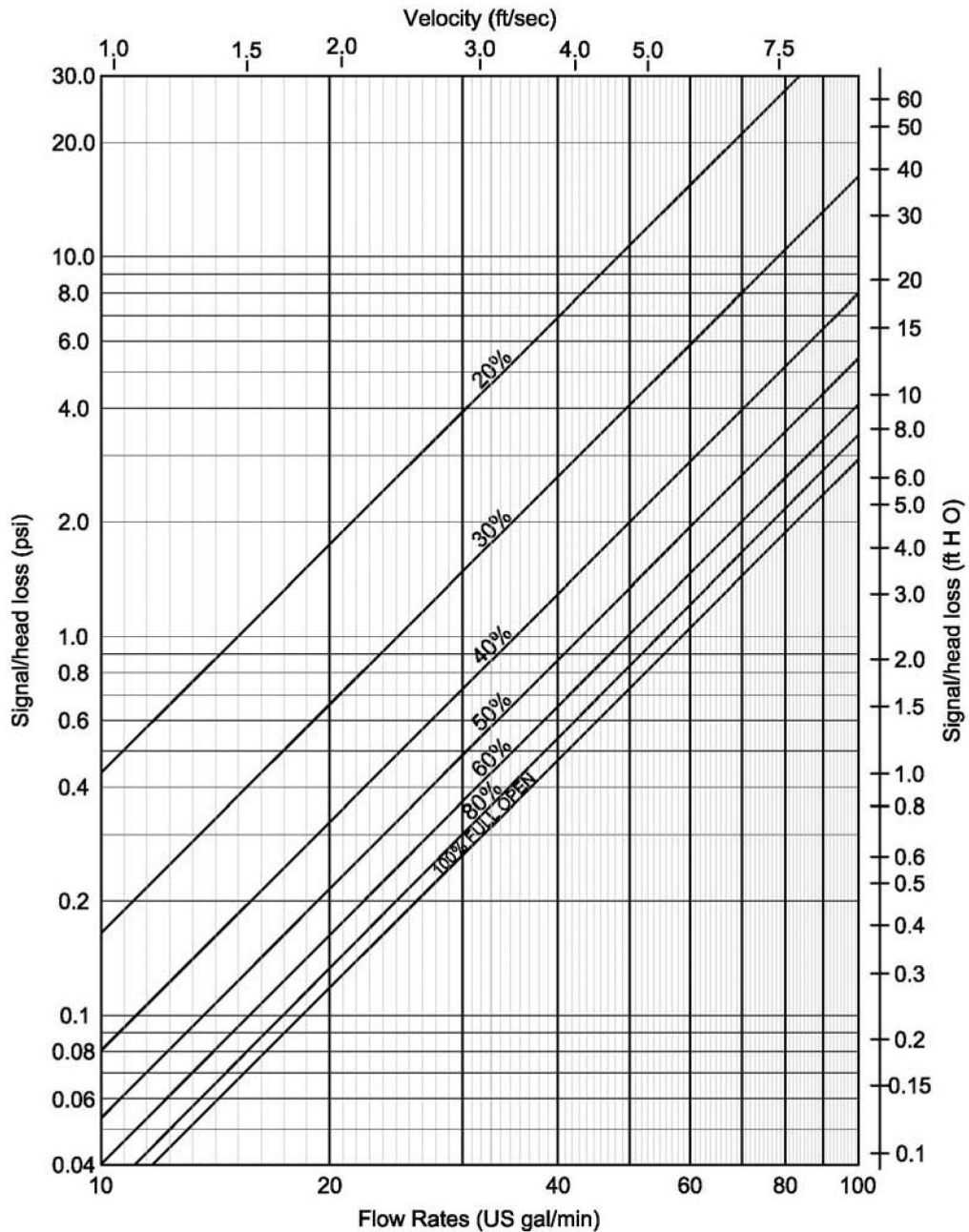

Graph of signal/Head Loss against Flow Rate indicating pressure drop attributable to the valve installed in a circuit.

Velocity based on average inside diameter of Schedule 40 pipe.

NOTE:

MULTI-FUNCTION VALVES PROVIDES REGULATION AND FLOW MEASUREMENT WITHIN AN ACCURACY OF 25%.

**2-1/2 MULTI-FUNCTION VALVE "MFV"
FLOW DIAGRAM
(FLANGED & GROOVED)**

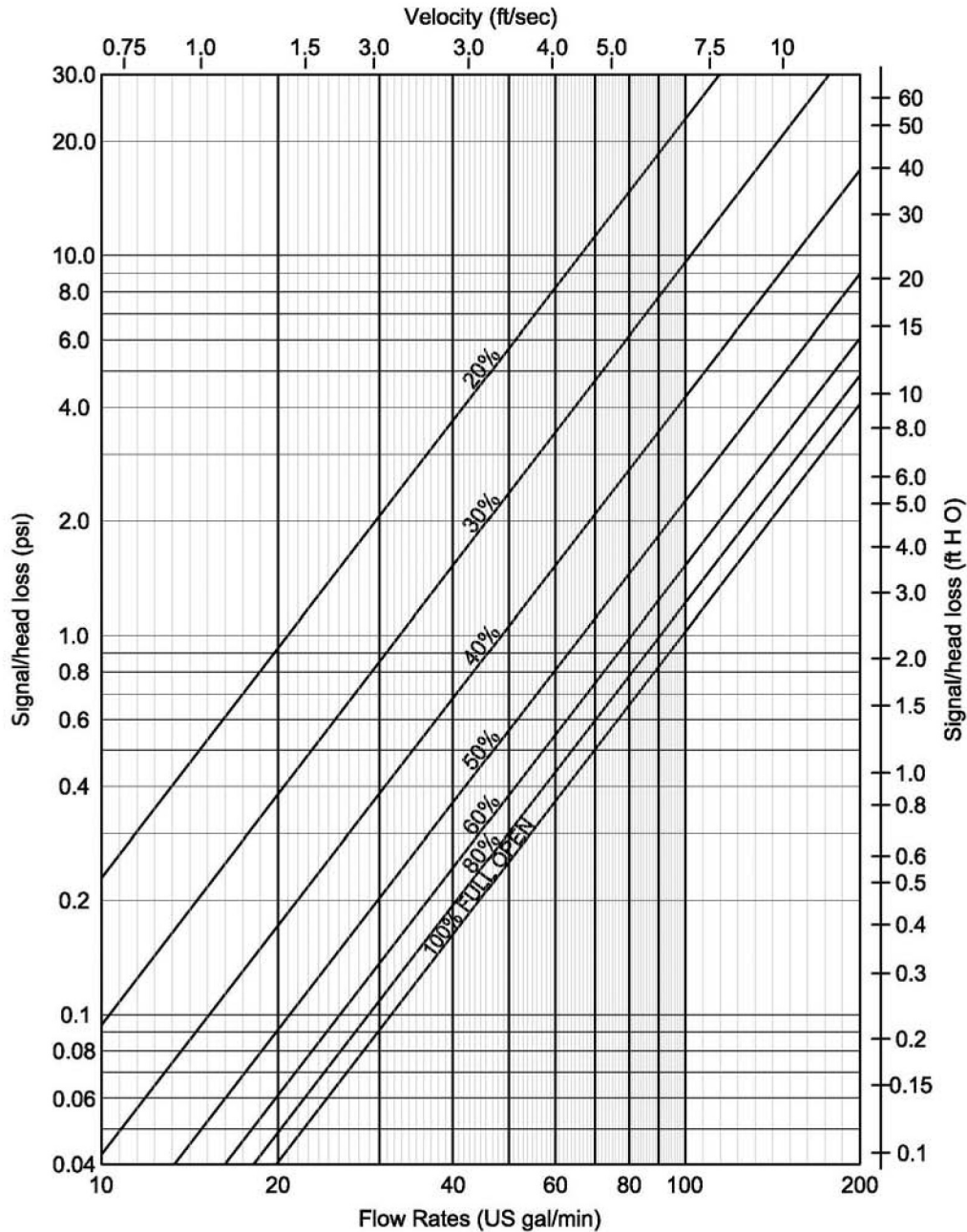

Graph of signal/Head Loss against Flow Rate indicating pressure drop attributable to the valve installed in a circuit.
Velocity based on average inside diameter of Schedule 40 pipe.

NOTE:

MULTI-FUNCTION VALVES PROVIDES REGULATION AND FLOW MEASUREMENT WITHIN AN ACCURACY OF 25%.

3" MULTI-FUNCTION VALVE "MFV" FLOW DIAGRAM (FLANGED & GROOVED)

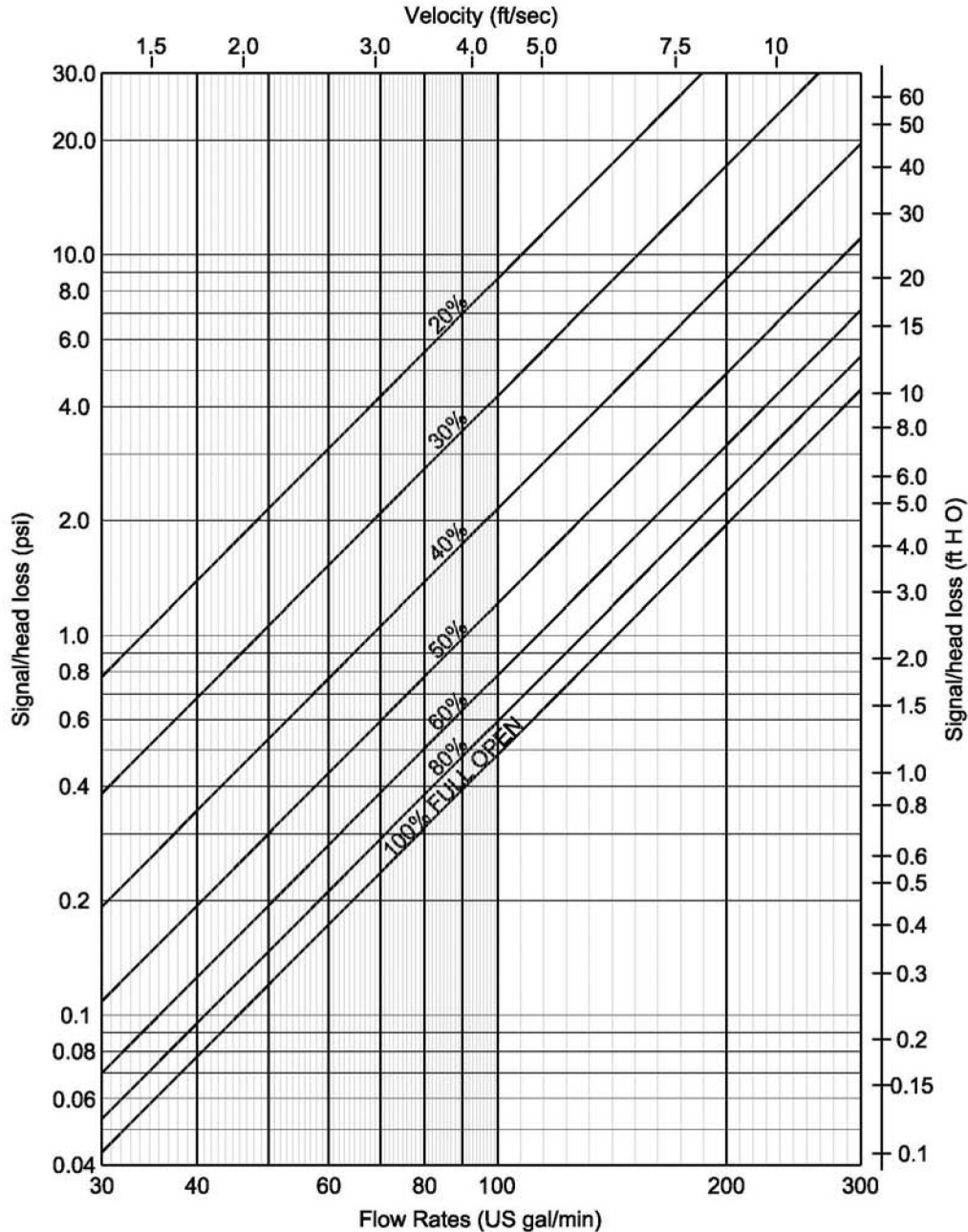

Graph of signal/Head Loss against Flow Rate indicating pressure drop attributable to the valve installed in a circuit.

Velocity based on average inside diameter of Schedule 40 pipe.

NOTE:

MULTI-FUNCTION VALVES PROVIDES REGULATION AND FLOW MEASUREMENT WITHIN AN ACCURACY OF 25%.

4" MULTI-FUNCTION VALVE "MFV" FLOW DIAGRAM (FLANGED & GROOVED)

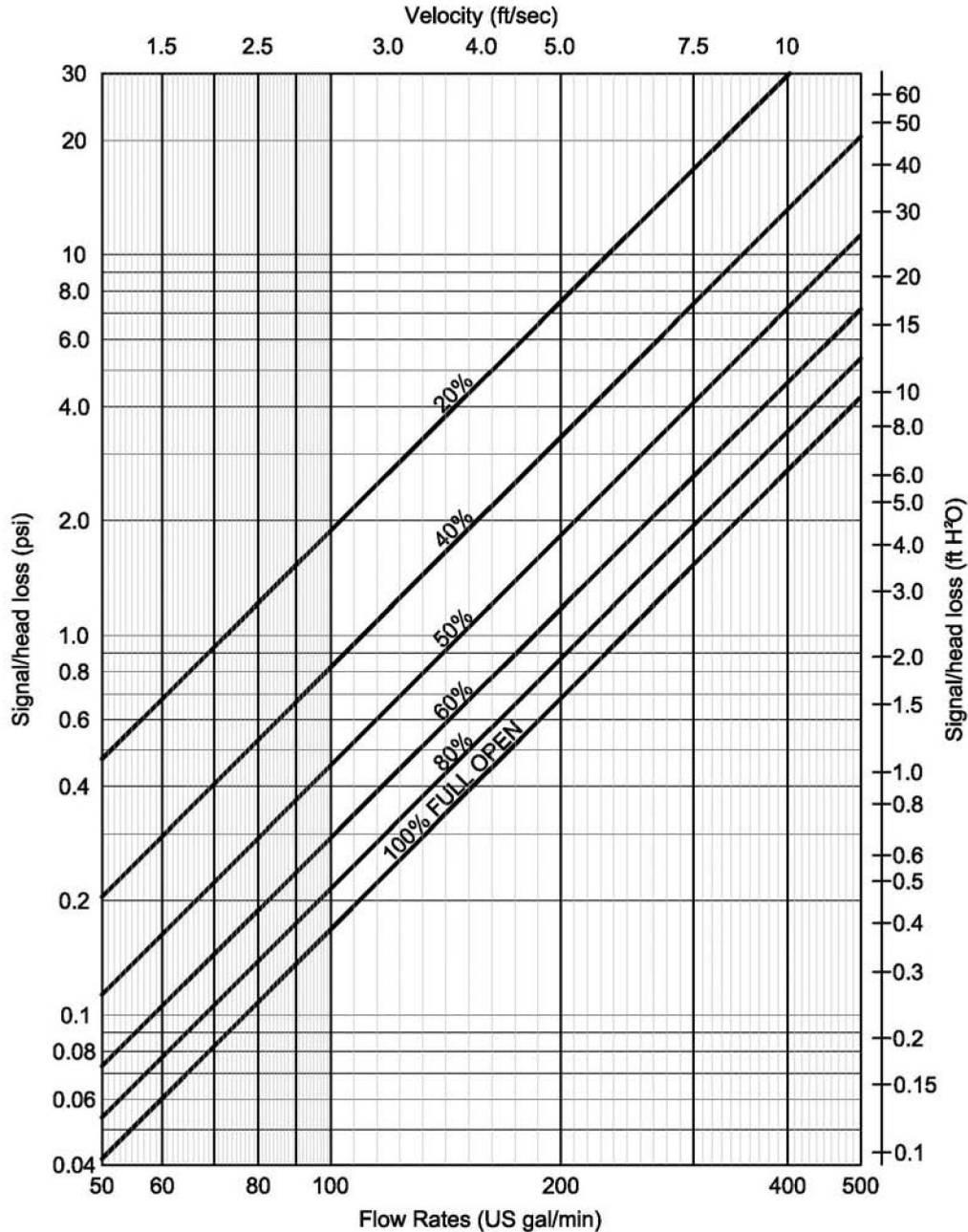

Graph of signal/Head Loss against Flow Rate indicating pressure drop attributable to the valve installed in a circuit.
Velocity based on average inside diameter of Schedule 40 pipe.

NOTE:

MULTI-FUNCTION VALVES PROVIDES REGULATION AND FLOW MEASUREMENT WITHIN AN ACCURACY OF 25%.

5" MULTI-FUNCTION VALVE "MFV"
FLOW DIAGRAM
(FLANGED & GROOVED)

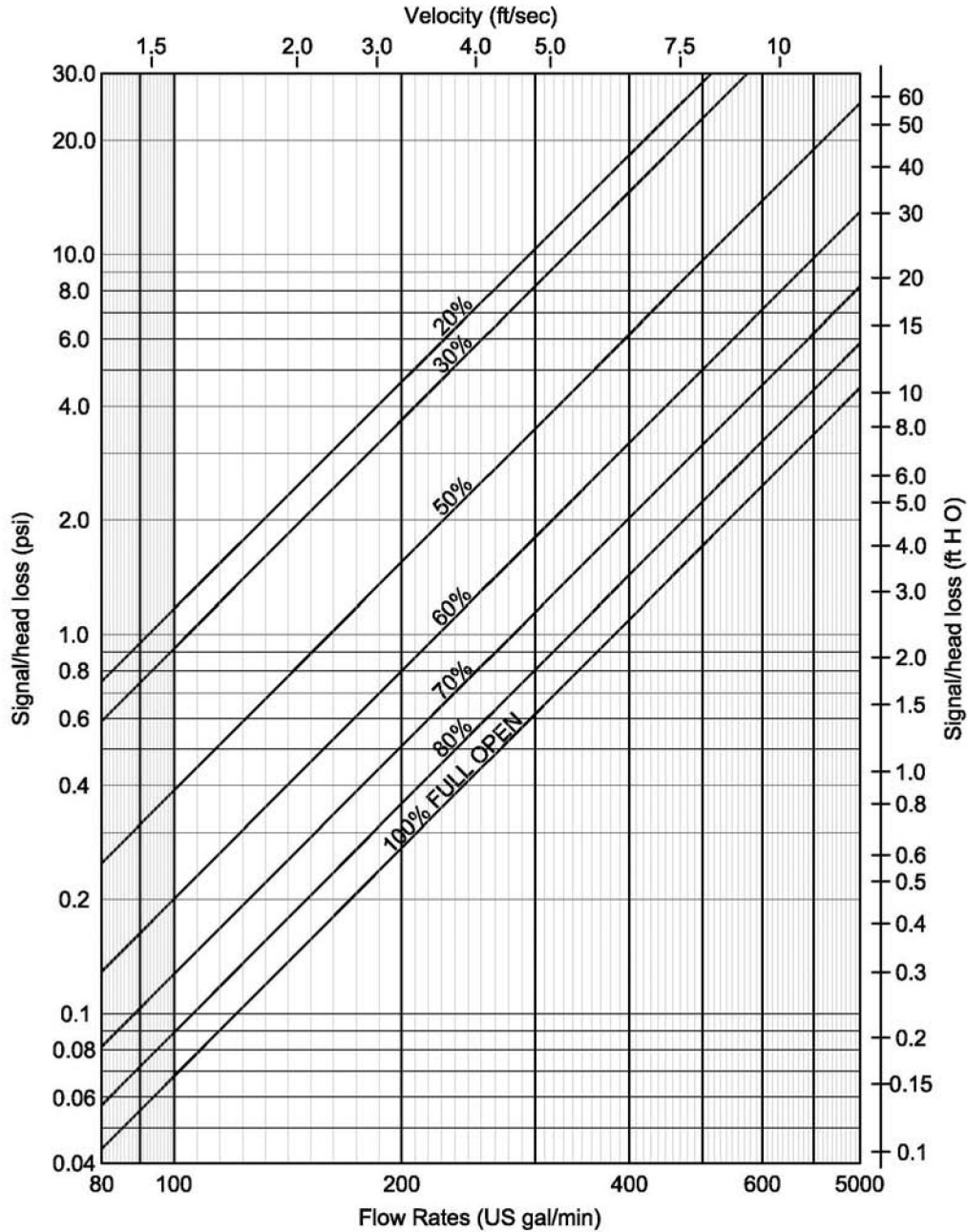

Graph of signal/Head Loss against Flow Rate indicating pressure drop attributable to the valve installed in a circuit.
 Velocity based on average inside diameter of Schedule 40 pipe.

NOTE:
 MULTI-FUNCTION VALVES PROVIDES REGULATION AND
 FLOW MEASUREMENT WITHIN AN ACCURACY OF 25%.

**6" MULTI-FUNCTION VALVE "MFV"
FLOW DIAGRAM
(FLANGED & GROOVED)**

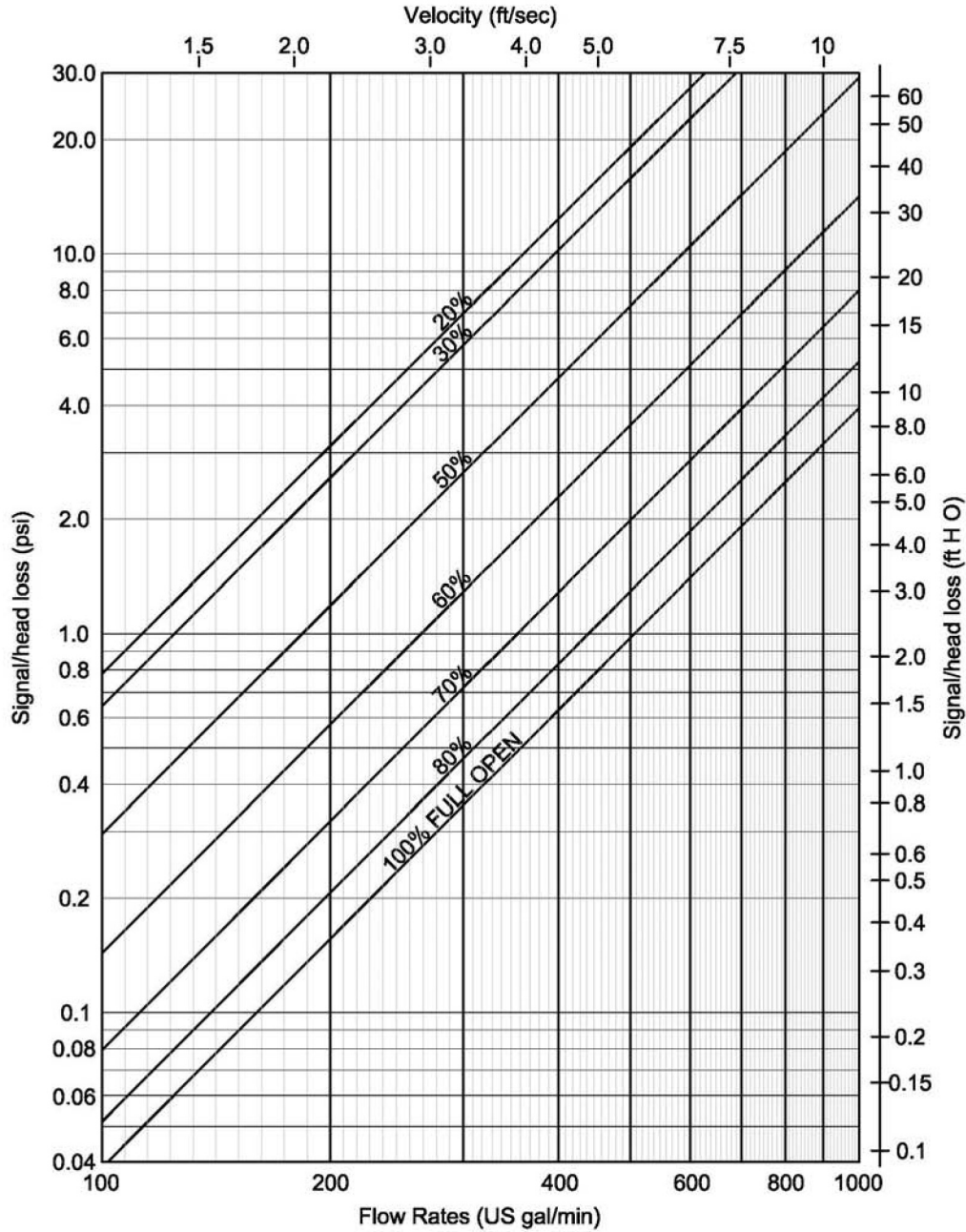

Graph of signal/Head Loss against Flow Rate indicating pressure drop attributable to the valve installed in a circuit.

Velocity based on average inside diameter of Schedule 40 pipe.

NOTE:

MULTI-FUNCTION VALVES PROVIDES REGULATION AND FLOW MEASUREMENT WITHIN AN ACCURACY OF 25%.

**8" MULTI-FUNCTION VALVE "MFV"
FLOW DIAGRAM
(FLANGED & GROOVED)**

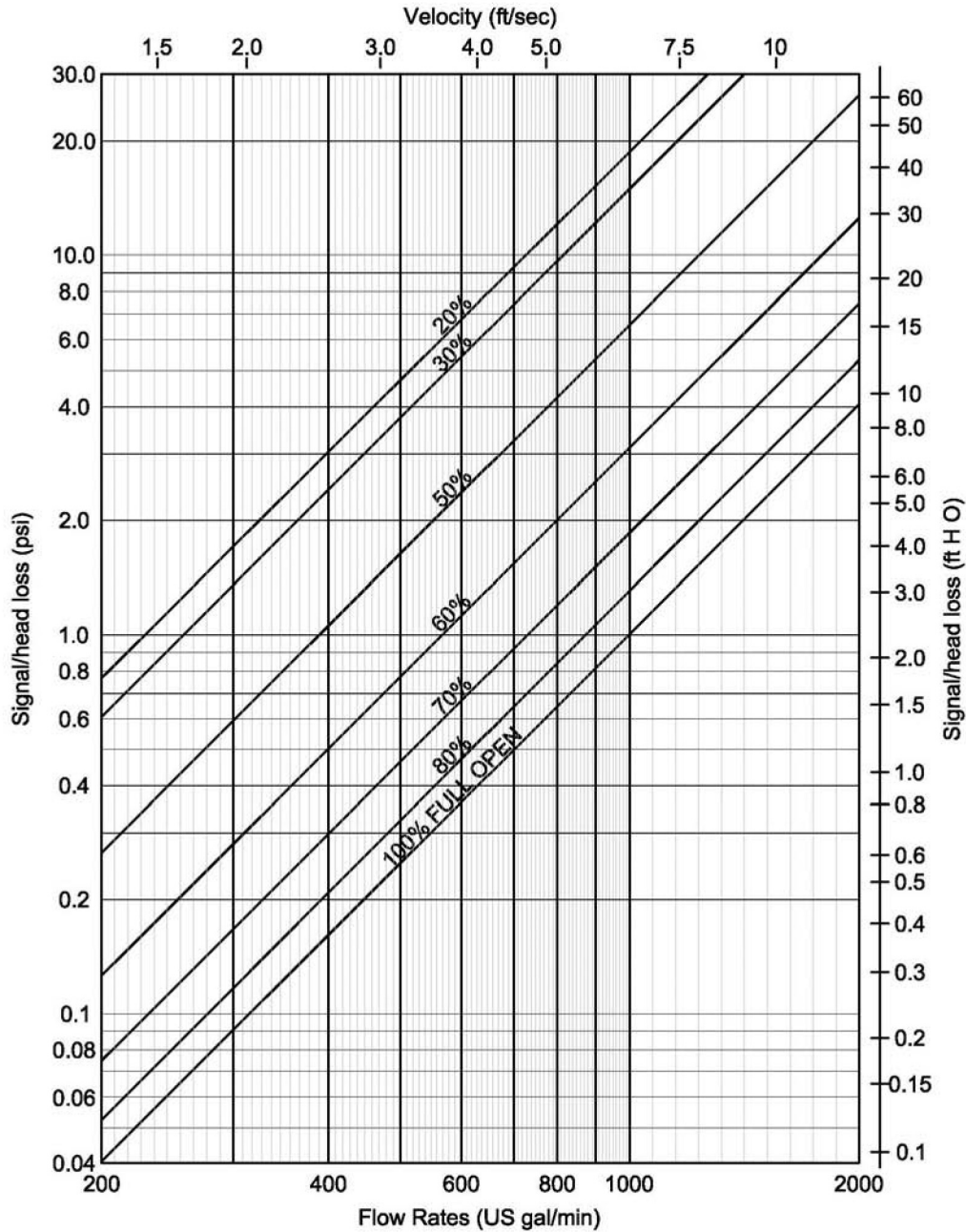

Graph of signal/Head Loss against Flow Rate indicating pressure drop attributable to the valve installed in a circuit.
Velocity based on average inside diameter of Schedule 40 pipe.

NOTE:

MULTI-FUNCTION VALVES PROVIDES REGULATION AND FLOW MEASUREMENT WITHIN AN ACCURACY OF 25%.

10" MULTI-FUNCTION VALVE "MFV" FLOW DIAGRAM (FLANGED & GROOVED)

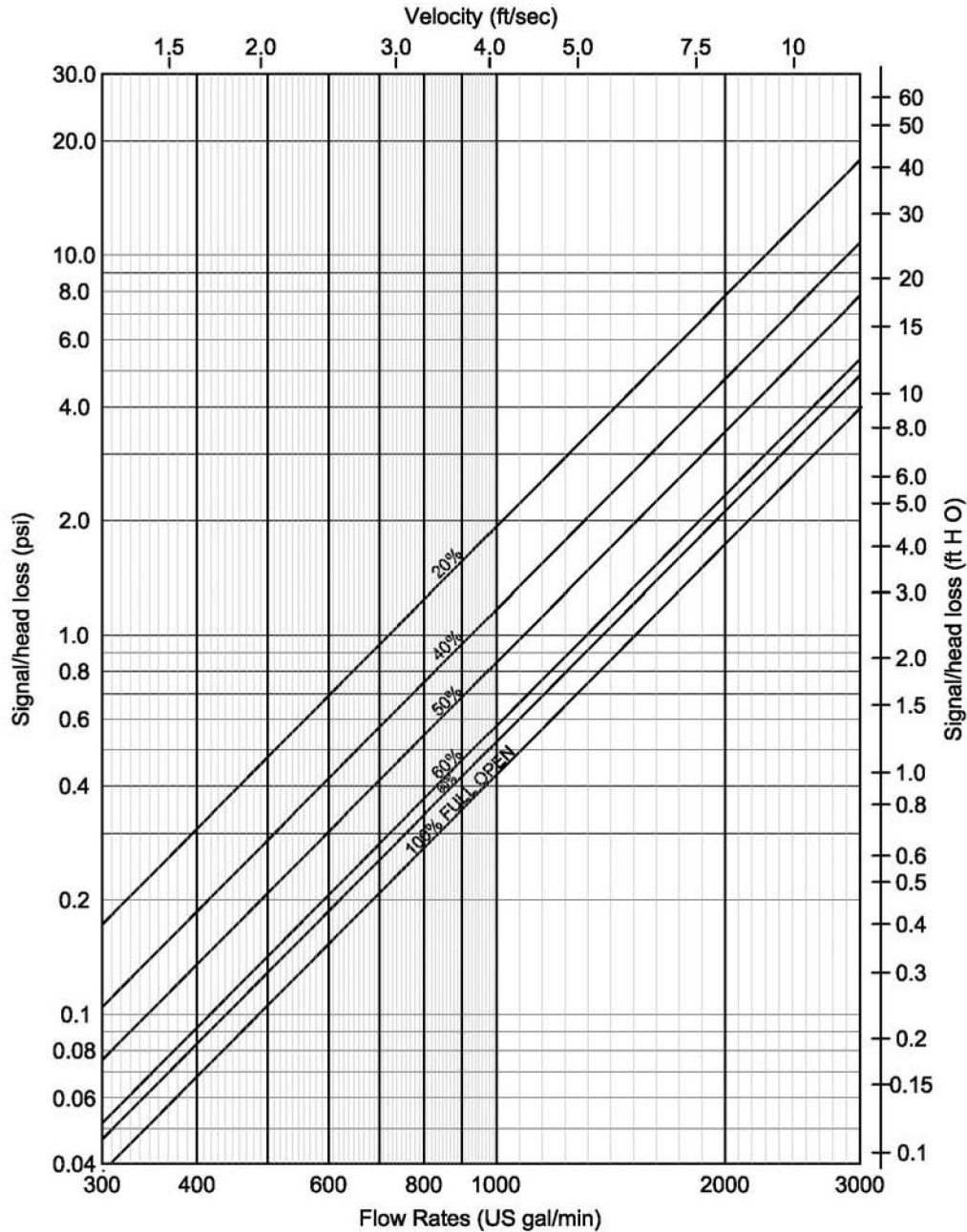

Graph of signal/Head Loss against Flow Rate indicating pressure drop attributable to the valve installed in a circuit.
Velocity based on average inside diameter of Schedule 40 pipe.

NOTE:
MULTI-FUNCTION VALVES PROVIDES REGULATION AND FLOW MEASUREMENT WITHIN AN ACCURACY OF 25%.



**12" MULTI-FUNCTION VALVE "MFV"
FLOW DIAGRAM
(FLANGED & GROOVED)**

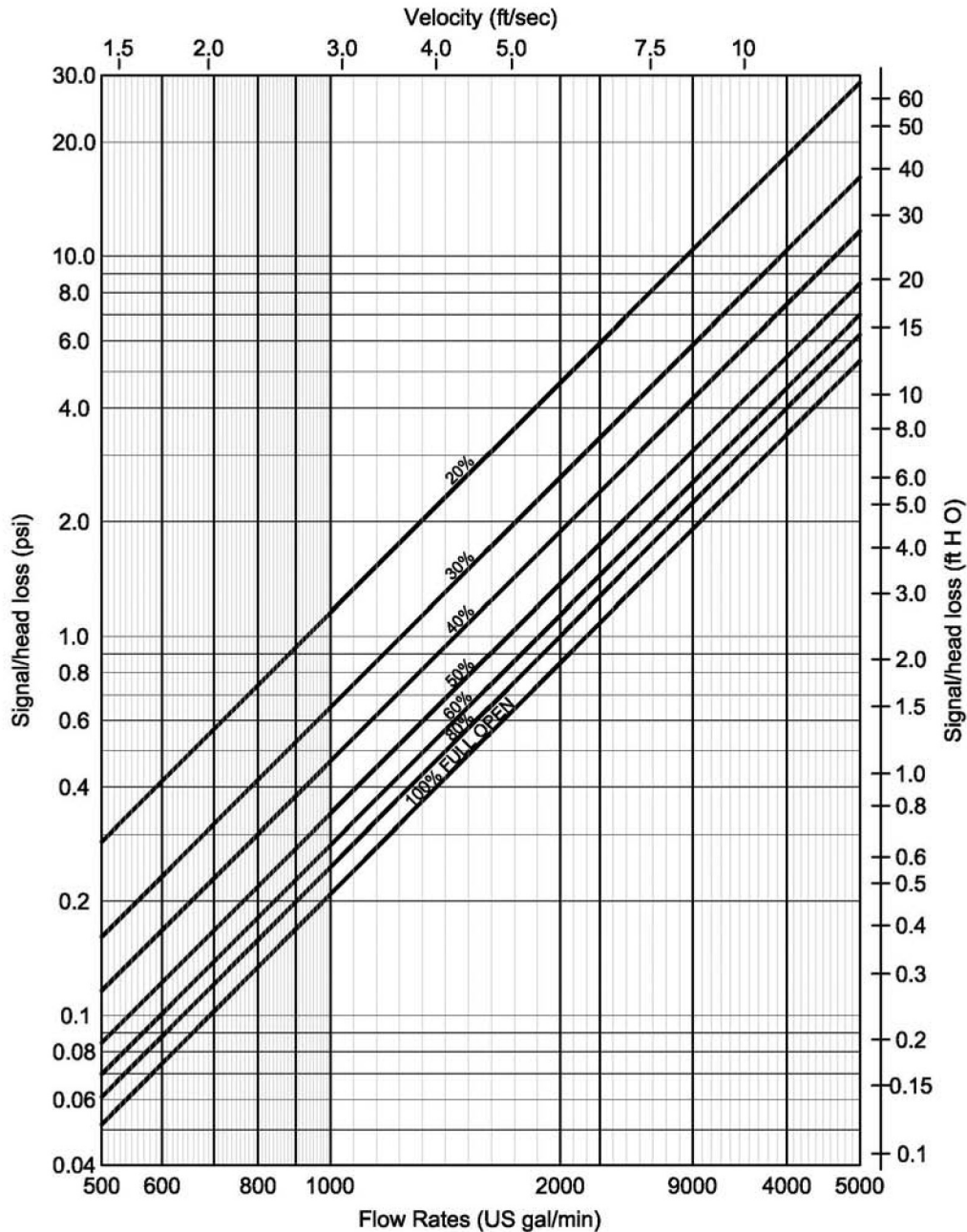

Graph of signal/Head Loss against Flow Rate indicating pressure drop attributable to the valve installed in a circuit.
Velocity based on average inside diameter of Schedule 40 pipe.

NOTE:
MULTI-FUNCTION VALVES PROVIDES REGULATION AND FLOW MEASUREMENT WITHIN AN ACCURACY OF 25%.

14" MULTI-FUNCTION VALVE "MFV"
FLOW DIAGRAM
(FLANGED & GROOVED)

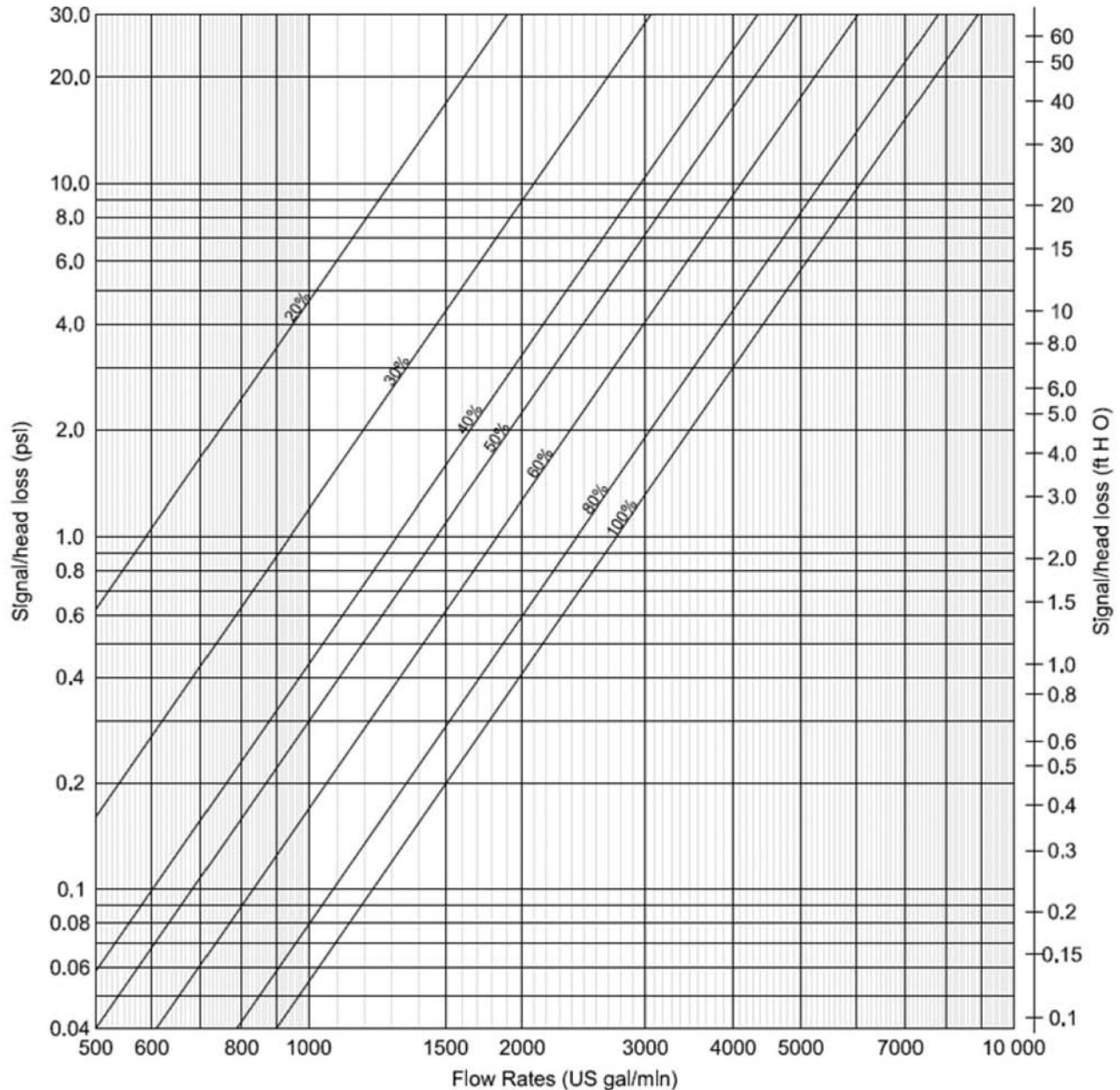

Graph of signal/head loss against flow rate indicating pressure drop attributable to the valve installed in a circuit.
 Velocity based on average inside diameter of schedule 40 pipe.

NOTE:
 MULTI-FUNCTION VALVES PROVIDES REGULATION AND FLOW MEASUREMENT WITHIN AN ACCURACY OF 25%.

16" MULTI-FUNCTION VALVE "MFV"
FLOW DIAGRAM
(FLANGED & GROOVED)

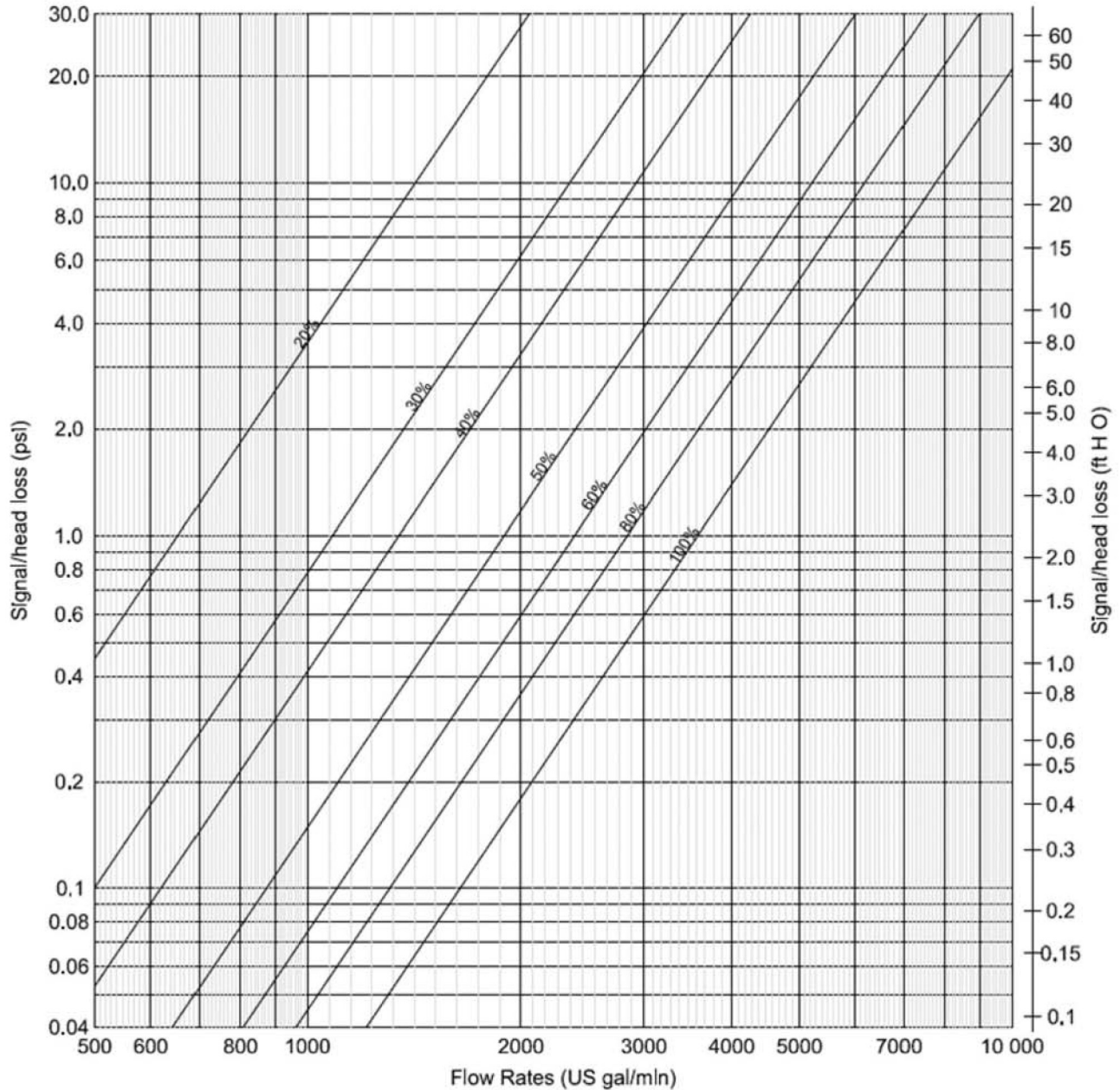

Graph of signal/head loss against flow rate indicating pressure drop attributable to the valve installed in a circuit.
 Velocity based on average inside diameter of schedule 40 pipe.

NOTE: MULTI-FUNCTION VALVES PROVIDES REGULATION AND FLOW MEASUREMENT WITHIN AN ACCURACY OF 25%

18" MULTI-FUNCTION VALVE "MFV"
FLOW DIAGRAM
(FLANGED & GROOVED)

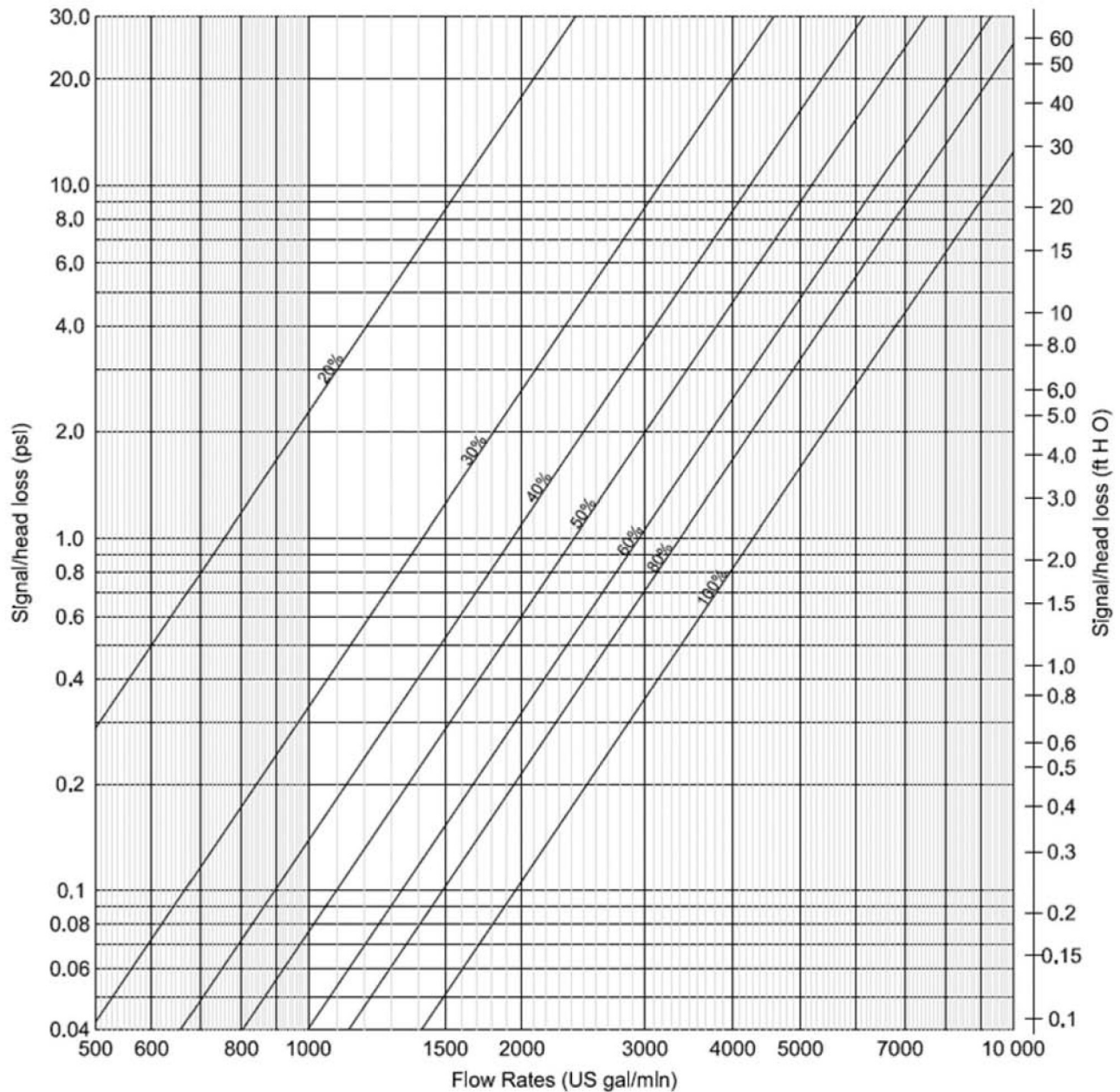

Graph of signal/head loss against flow rate indicating pressure drop attributable to the valve installed in a circuit.
 Velocity based on average inside diameter of schedule 40 pipe.

NOTE: MULTI-FUNCTION VALVES PROVIDES REGULATION AND FLOW MEASUREMENT WITHIN AN ACCURACY OF 25%



Terms and Conditions

LIMITED WARRANTY: We warrant to our immediate customer and to the ultimate consumer that products of our manufacture will be free of defects in material and workmanship under normal use and service for the following time periods, when installed and maintained in accordance with our instructions. Pumps Products: One (1) year from date of invoicing. As used herein, "the ultimate consumer" is defined as the purchaser who first uses the product after its initial installation or, in the case of product designed for non permanent installation, the first owner who used the product. It is the purchaser's or any sub-vendee's obligation to make know to the ultimate consumer the terms and conditions of this warranty. This warranty gives you specific legal rights, and there may also be other rights which vary from province to province. In the event the product is covered by the Consumer Product Warranty (1) the duration of any implied warranty associated with the product by virtue of said law is limited to the same duration as stated herein, (2) this warranty is a LIMITED WARRANTY, and (3) no claims of any nature whatsoever shall be made against us, until the ultimate consumer, his successor, or assigns, notifies us in writing of the defect, and delivers the product and/or defective part(s) freight prepaid to our factory or nearest authorized service station. THE SOLE AND EXCLUSIVE REMEDY FOR BREACH OF ANY AND ALL WARRANTIES WITH RESPECT TO ANY PRODUCT SHALL BE TO REPLACE OR REPAIR AT OUR ELECTION, F.O.B. POINT OF MANUFACTURE OR AUTHORIZED REPAIR STATION, SUCH PRODUCTS AND/OR PARTS REPAIR STATION, SUCH PRODUCTS AND/OR PARTS AS PROVEN DEFECTIVE. THERE SHALL BE NO FURTHER LIABILITY, WHETHER BASED ON WARRANTY, NEGLIGENCE OR OTHERWISE. Unless expressly stated otherwise guarantees in the nature of performance specifications furnished in addition to the foregoing material and workmanship warranties on a product manufactured by us, if any, are subject to laboratory tests corrected for field performance. Any additional guarantees, in the nature of performance specifications must be in writing and such writing must be signed by our authorized representative. Due to inaccuracies in field testing if a conflict arises between the results of field testing conducted by or for user, and laboratory test corrected for field performance, the latter shall control. Components or accessories supplied by us but manufactured by others are warranted only to the extent of and by the terms and conditions of the original manufacturer's warranty. RECOMMENDATIONS FOR SPECIAL APPLICATIONS OR THOSE RESULTING FROM SYSTEMS ANALYSES AND EVALUATIONS WE CONDUCT WILL BE BASED ON OUR BEST AVAILABLE EXPERIENCE AND PUBLISHED INDUSTRY INFORMATION. SUCH RECOMMENDATIONS DO NOT CONSTITUTE A WARRANTY OF SATISFACTORY PERFORMANCE AND NO SUCH WARRANTY IS GIVEN. This warranty shall not apply when damage is caused by (A) improper installation, (B) improper voltage (C) lightning (D) sand or other abrasive material (E) scale or corrosion build-up due to excessive chemical content. Any modification of the original equipment will also void the warranty. We will not be responsible for loss, damage or labour cost due to interruption of service caused by defective parts. Neither will we accept charges incurred by others without our prior written approval. This warranty is void if our inspection reveals the product was in a manner inconsistent with normal industry practice and/or our specific recommendations.

The purchaser is responsible for communication of all necessary information regarding the application and use of the product. UNDER NO CIRCUMSTANCES WILL BE RESPONSIBLE FOR ANY OTHER DIRECT OR CONSEQUENTIAL DAMAGES, INCLUDING BUT NOT LIMITED TO LOST PROFITS, LOST INCOME, LABOUR CHARGES, DELAYS IN PRODUCTION, IDLE PRODUCTION, WHICH DAMAGES ARE CAUSED BY ANY DEFECTS IN MATERIAL AND/OR WORKMANSHIP AND/OR DAMAGE OR DELAYS IN SHIPMENT. THIS WARRANTY IS EXPRESSLY IN LIEU OF ANY OTHER EXPRESS OR IMPLIED WARRANTY, INCLUDING ANY WARRANTY OF MERCHANTABILITY OR FITNESS FOR A PARTICULAR PURPOSE. No rights extended under this warranty shall be assigned to any other person, whether by operation of law or otherwise, without our prior written approval. If any litigation is commenced between the parties hereto for the enforcement of any rights hereunder, the successful party in subject litigation shall be entitled to receive from the unsuccessful party all costs incurred in connection therewith, including a reasonable amount of attorney's fees. YOUR ACCEPTANCE OF ANY GOODS SUPPLIED BY US, OR ON OUR BEHALF, SHALL, WITHOUT LIMITATION CONSTITUTE ACCEPTANCE OF ALL TERMS AND CONDITIONS STATED ABOVE.

PROJECT: _____
CONTRACTOR: _____
ENGINEER: _____
DATE: _____





Terms and Conditions

Our acceptance of your order is expressly conditioned on the general terms and conditions set forth below and all terms stated on the face of this form. The contract shall not include any deviating or additional terms unless expressly agreed to in writing and signed by an officer of our company.

PRICES: All prices are subject to change without notice and all shipments will be invoiced at the price in effect at the time of shipment, except when otherwise agreed to in writing by our authorized representative. Published prices are for products of our standard design and construction and any item not covered by the most recent published price list must be referred to us for special pricing. Prices do not include freight. Weights shown in price lists are approximate shipping weights. The amount of any applicable present or future tax or other government charge upon the production, sale, shipment or use of goods ordered or sold is not in the price and will be added to billing unless you provide us with an appropriate exemption certificate.

QUOTATION: Prices quoted by us are valid for 30 days from date of quotation unless we have otherwise specified in writing. Clerical errors on quotations are subject to our correction and such errors will not be binding.

CANCELLATION & REVISIONS: No purchase orders accepted and acknowledged by us may be cancelled or revised by you except with our prior written consent and upon payment of reasonable cancellation charges compensating us for all costs incurred in work done and material purchased. We reserve the right to determine what constitutes reasonable cancellation charges.

RETURN OF EQUIPMENT: No equipment shall be returned to us without first obtaining a written Returned Goods Authorization and shipping instruction from us. The returner must prepay the charges in full for transportation to our factory. Credit allowed for new, undamaged equipment of current standard design will be 80% of the invoiced price or current billing price, whichever is less. Equipment which has been used, however slight, will not be accepted. Authorization will not be given for return of equipment, (1) which would, in our opinion, result in an excess in the amount of stock we normally carry, (2) not invoiced within the last 3 months, or (3) which is non-standard and manufactured specifically to a buyer's specifications. For non-standard equipment not of our manufacture, the only credit allowed will be such credit as may be allowed by the manufacturer of such equipment. Equipment must be returned within 30 days of the issuance of the Returned Goods Authorization. No item with a net value of less than \$50.00 will be authorized for return. Unauthorized returns may be refused and/or returned freight collect.

CREDIT & PAYMENT: Payment is due as noted on our invoice. Overdue accounts are subject to a service charge. All orders are subject to approval of our credit department and we may require full or partial payment in advance. Pro rata payments shall become due as shipments are made. If the shipments are delayed by you for any cause, payments shall become due from date on which we are prepared to make shipment and storage shall be at your risk and expense. If manufacture is delayed by you for any

cause, a partial payment based upon the proportion of the order completed shall become due from the date on which we are notified of the delay.

SECURITY INTEREST: We shall have a lien on all goods sold as security for payment on the invoice price, and upon request you shall provide and execute a financing statement showing such lien.

DELIVERY: We will reasonable effort to meet your delivery requirement provided you provide us, on a timely basis, all approvals, technical data, instructions and credit approval requirements needed for release of the shipment. However, all delivery and/or shipment dates are estimates only unless we have expressly guaranteed delivery of such dates in writing at your specific request. In no event shall we have any liability if delivery is delayed by strikes, labour disturbances, material shortages, plant calamities or disaster, acts of God, government actions, civil disturbance, the failure of any pre-supposed condition of the contract, withholding shipments due to credit clearance, or other interferences beyond our reasonable control, and the date of delivery shall be extended for a period of time equal to the time lost because of any such reason.

SHIPPING: Unless you specify in writing and we acknowledge in writing, (A) goods will be boxed or crated as we may deem proper for protection against normal handling and for domestic shipment, (B) routing and manner of shipment will be at our discretion, and may be insured at your expense. An extra charge will be made for special handling. All shipments are F.O.B. point of manufacture. Delivery of goods to the initial carrier will constitute delivery to you and all goods will be shipped at your risk. A claim for loss or damage in transit must be entered with the carrier and prosecuted by you. Acceptance of material from a common carrier constitutes a waiver of any claims against us for delay, damage or loss.

GOVERNING LAW: It is understood and agreed that these Terms and Condition of Sale shall be interpreted under and pursuant to the laws of the Province of Quebec; you agree that any action at law which is related to any contract of sale brought against the company shall be filed in the appropriate court located in the Province of Quebec.

PROJECT: _____
CONTRACTOR: _____
ENGINEER: _____
DATE: _____



We are proud supplier for the following
completed and on going projects :



250 West Street
250 W St, Redmond, Utah
84652, United States



John Deere,
2624 Old U.S. 169,
Coffeyville, KS 67337, USA



Le Séville
2183 Ste-Catherine O.
Street,
Montreal, QC H3H 1M9



Havre du Ruisseau
155, Chevigny Place
Sainte-Therese (Quebec)
J7E 0A1

Sales and Service:

Quebec, Canada
Tel. : (450) 621-2995
Fax : (450) 621-4995

Lake Worth
Florida, USA
33467-5749

Toronto, Canada
Tel. : +1 (647) 544-2995

www.flofab.com

SERVICE 24/7 : parts@flofab.com

