



COMPLETE PRODUCT LINE

Manufacturer of Pumps, Tanks,
Heat Exchangers & Accessories



PUMPS



PACKAGES



ACCESSORIES

www.flofab.com
005-cat-2018-compv

HISTORY

Flo Fab was established in 1981 by Denis Gauvreau who created and developed the product line, which is constantly being perfected by Marc Gauvreau and a team of professional engineers and designers. It is a combination of existing designs from several renowned products and the innovative ideas of a new generation professionals.

Founder 1981

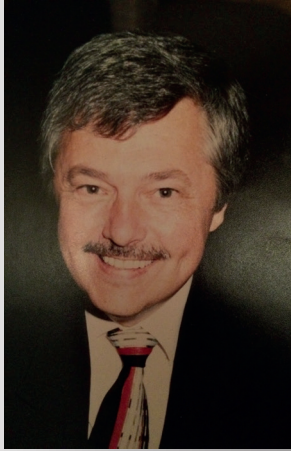

Through the years, Flo Fab has acquired several companies and service entities including: AQUA-PROFAB (ASME Tanks manufacturer), MÉNARD, LÉONARD ÉLECTRIQUE, PMA. Moreover, Flo Fab also purchased equipment, fabrication designs and patterns from IDEALCO, a manufacturer of shell and tube type heat exchangers.





The after-sales services, sales, engineering, R&D, production, quality control, accounting and administration departments of all the above companies share the same location.

In December 2014, Marc Gauvreau, son of the founder, acquired all of the company's shares. Flo Fab and is constantly investing in new state-of-the-art innovations, new products like the XRI series and Prefab Skid for Hydronic Heating & cooling system and pumping systems. This has allowed Flo Fab to retain our competent and qualified staff of professionals with a variety of specialized skills that continually work on improving our existing products and adding new engineered solutions that exceed customers' expectations .

Flo Fab has grown quite rapidly and now proudly offers of a wide range of products available directly from one manufacturer. This includes pumps and pump packages, tanks, heat exchangers and hydronic accessories. This allows each project's stakeholders to enjoy economical savings, peace of mind, best value for their investment and optimized total cost of ownership.

TABLE OF CONTENTS

VERTICAL IN-LINE PUMPS.....	3
FEATURE PRODUCT.....	3
SERIES XRI VARIOUS CONFIGURATIONS.....	4
HORIZONTAL BASE MOUNTED & CLOSE COUPLED END SUCTION PUMPS.....	5
SPLIT CASE DOUBLE SUCTION / MULTISTAGE / CLOSE COUPLED STAINLESS PUMPS.....	5
CONDENSATE & TURBINE PUMPS.....	6
ASME TANKS & AIR SEPARATORS.....	7
HEAT EXCHANGERS.....	6
HOW TO PRICE A PACKAGE.....	7
ALL SUBMERSIBLES.....	8-21
TYPICAL MECHANICAL ROOM.....	22
HYDRONIC ACCESSORIES.....	23
SUBMERSIBLE PUMPS (PLUMBING).....	24
PACKAGED SYSTEMS.....	25-27
DIFFERENT SYSTEMS.....	28-29
COMPLETED AND ONGOING PROJECTS.....	30

				
SERIES	500	600	840SC	880RI
TYPE	Circulating Pump	In-Line Circulator	Vertical In-Line Centrifugal Split Coupling	Vertical In-Line Centrifugal Split Coupling
CAPACITIES	up to 234 USGPM (54 m ³ /hr)	up to 290 USGPM (61 m ³ /hr)	454 to 8000 USGPM (1816 m ³ /hr)	Up to 3000 USGPM (680 m ³ /hr)
HEAD	up to 43 ft. (14 m)	up to 120 ft. (37 m)	up to 410 ft. (125 m)	up to 650 ft. (198 m)
PRESSURE	up to 145 PSI (999 kPa)	up to 250 PSI (1724 kPa)	up to 600 PSI (4136 kPa)	up to 250 PSI (1724 kPa)
HORSEPOWER	up to 2/5 HP (280 kW)	up to 10 HP (7.5 kW)	up to 400 HP (298 kW)	up to 200 HP (149kW)
DRIVES	ECM Motor ERP Ready	56C Electric Motors	TC Electric Motors	TC Electric Motors
APPLICATIONS	Water / Glycol	Water / Glycol	Water / Glycol	Water / Glycol
TEMPERATURE	up to 220°F (104°C)	up to 250°F (121°C)	up to 300°F (149°C)	up to 300°F (149 °C)
CONSTRUCTION MATERIAL	Cast Iron, Stainless, Bronze	Cast Iron, Bronze Fitted or All Bronze	Cast Iron, Bronze Fitted as Standard. Other materials also available	Cast Iron, Bronze Fitted as Standard. Other materials also available

	
SERIES	XRI
TYPE	Universal 10 positions Vertical / Horizontal Centrifugal Pump with removable Impeller
CAPACITIES	up to 15850 USGPM 3600 m ³ /hr
HEAD	up to 655ft (200m)
PRESSURE	up to 600 PSI (4136 kPa)
HORSEPOWER	up to 1000 HP (746 kW)
DRIVES	TC Electric Motors
APPLICATIONS	Water / Glycol
TEMPERATURE	up to 300°F (149°C)
CONSTRUCTION MATERIAL	Cast Iron, Bronze Fitted as Standard. Other materials also available

- FEATURE PRODUCT -

VERTICAL POSITION

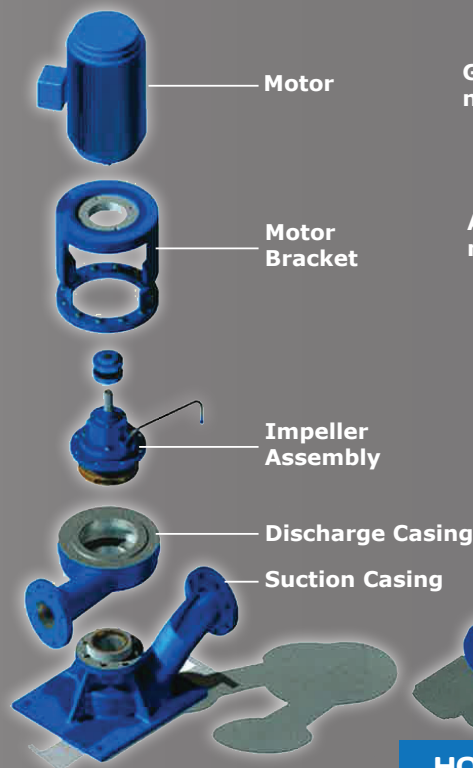

Series XRI construction

Grout not required



Alignment not required



HORIZONTAL POSITION

SERIES XRI VARIOUS CONFIGURATIONS

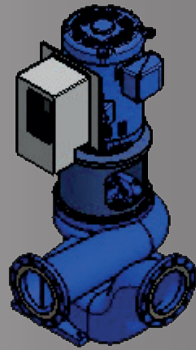

CV

CROSSED VERTICAL

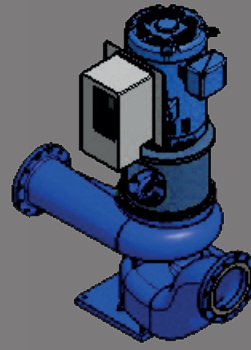

IV

IN-LINE VERTICAL

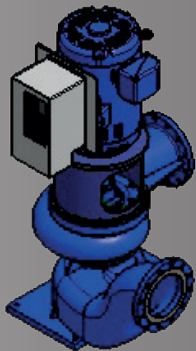

LV

L-SHAPED VERTICAL

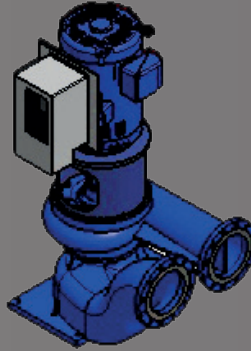

UV

U-SHAPED VERTICAL

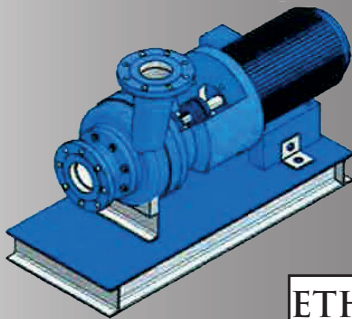

ETH

END SUCTION TOP HORIZONTAL

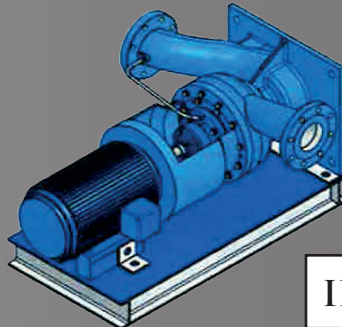

IH

IN-LINE HORIZONTAL

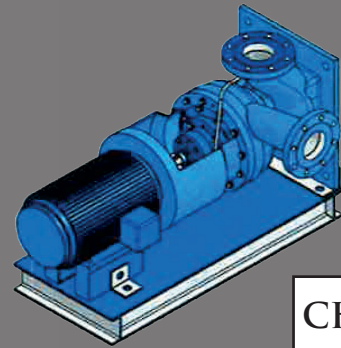

CH

CROSSED HORIZONTAL

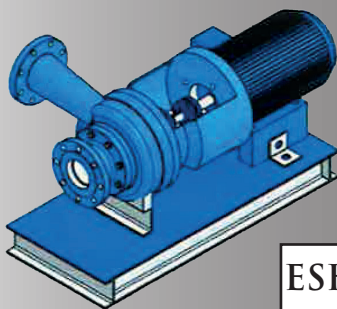

ESH

END SUCTION HORIZONTAL

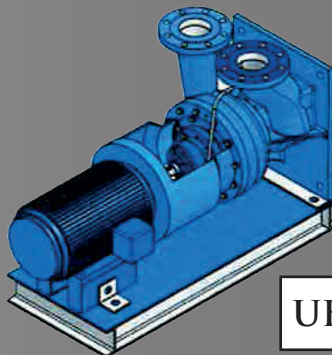

UH

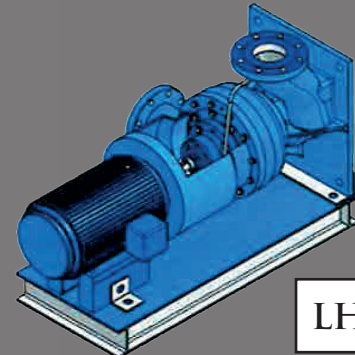

U-SHAPED HORIZONTAL





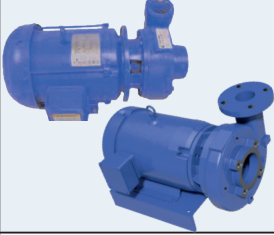

LH

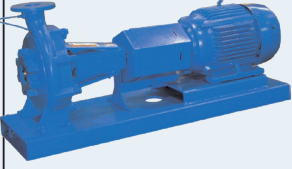



L-SHAPED HORIZONTAL





VERTICAL IN-LINE, HORIZONTAL BASE MOUNTED, CLOSED COUPLED, AND SPLIT CASE DOUBLE SUCTION TYPE PUMPS

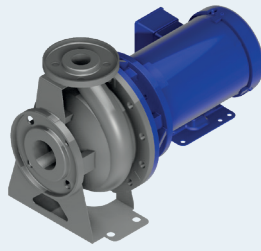



				
SERIES	880	1000/1004	2000	2300 / 2600
TYPE	Compact In-Line Centrifugal	End Suction, Close Coupled	Radially Split Bearing Frame Pump Mounted With Flexible Coupling Back PULL-OUT Design	Radially Split Bearing Frame Pump Mounted With Flexible Coupling Back PULL-OUT Design
CAPACITIES	up to 3000 USGPM (680 m ³ /hr)	up to 1900 USGPM (431 m ³ /hr)	up to 1900 USGPM (431 m ³ /hr)	from 1900 to 6500 USGPM (432 to 1476 m ³ /hr)
HEAD	up to 650 ft. (198 m)	up to 43 ft. (14 m)	up to 120 ft. (37 m)	up to 410 ft. (125 m)
PRESSURE	up to 250 PSI (1724 kPa)	up to 175 PSI (1206 kPa)	up to 175 PSI (1206 kPa) with 125# flanges	up to 400 PSI (1206 kPa) with 400# flanges
HORSEPOWER	up to 200 HP (149 kW)	up to 200 HP (149 kW)	up to 200 HP (149 kW)	up to 500 HP (373 kW)
DRIVES	JM Electric Motors	JM Electric Motors	T Frame Electric Motors or Diesel Engines	T Frame Electric Motors or Diesel Engines
APPLICATIONS	Water / Glycol	Water / Glycol	Water / Glycol	Water / Glycol
TEMPERATURE	up to 300°F (149 °C)	up to 300°F (149 °C)	up to 300°F (149 °C)	up to 300°F (149 °C)
CONSTRUCTION MATERIAL	Cast Iron, Bronze Fitted as Standard. Other materials also available	Cast Iron, Bronze Fitted as Standard. Other materials also available	Cast Iron, Bronze Fitted as Standard. Other materials also available	Cast Iron, Bronze Fitted as Standard. Other materials also available

				
SERIES	4800L	4800U	4800/4800H/4900	4800V
TYPE	Single Stage, Double Suction Split Case	Single Stage, Double Suction Split Case	Horizontally Mounted, Single Stage, Double Suction Split Case	Vertically Mounted, Single Stage, Double Suction Split Case
CAPACITIES	up to 12000 USGPM (2725 m ³ /hr)	up to 12000 USGPM (2725 m ³ /hr)	up to 12700 USGPM (2884 m ³ /hr)	up to 12700 USGPM (2884 m ³ /hr)
HEAD	up to 750 ft. (227 m)	up to 750 ft. (227 m)	up to 625 ft. (190 m)	up to 625 ft. (190 m)
PRESSURE	up to 600 PSI (4136 kPa)	up to 600 PSI (4136 kPa)	up to 600 PSI (4136 kPa)	up to 600 PSI (4136 kPa)
HORSEPOWER	up to 800 HP (597 kW)	up to 800 HP (597 kW)	up to 1750 HP (1305 kW)	up to 1750 HP (1305 kW)
DRIVES	Electric Motors, Diesel Engines, Steam Turbines	Electric Motors, Diesel Engines, Steam Turbines	Electric Motors, Diesel Engines, Steam Turbines	Electric Motors, Diesel Engines, R.A.G.D
APPLICATIONS	Water / Glycol	Water / Glycol	Water / Glycol	Water / Glycol
TEMPERATURE	up to 300°F (149°C)	up to 300°F (149°C)	up to 300°F (149°C)	up to 300°F (149°C)
CONSTRUCTION MATERIAL	Cast Iron, Bronze Fitted as Standard. Other materials also available	Cast Iron, Bronze Fitted as Standard. Other materials also available	Cast Iron, Bronze Fitted as Standard. Other materials also available	Cast Iron, Bronze Fitted as Standard. Other materials also available

**MULTISTAGE AND CLOSED COUPLED STAINLESS STEEL TYPE PUMPS
SHELL AND TUBE, PLATE AND FRAME, BRAZED TYPE HEAT EXCHANGERS**

				
SERIES	PSMCF	PSM	PSF	PST
TYPE	Vertical Multistage	Vertical Multistage	Flanged Close Coupled Centrifugal	NPT Close Coupled Centrifugal
CAPACITIES	up to 250 USGPM (56 m ³ /hr)	up to 792 USGPM (180 m ³ /hr)	13 to 380 USGPM (3 to 86 m ³ /hr)	up to 52 USGPM (12m ³ /hr)
HEAD	up to 930 ft. (283 m)	up to 930 ft. (283 m)	up to 150 ft. (46 m)	up to 150 ft. (46 m)
PRESSURE	up to 430 PSI (2964 kPa)	up to 430 PSI (2964 kPa)	up to 145 PSI (1000 kPa)	up to 115 PSI (793 kPa)
HORSEPOWER	up to 50 HP (37 kW)	up to 100 HP (75 kW)	up to 15 HP (11 kW)	up to 3 HP (2.2 kW)
DRIVES	Vertical Electrical Motor	Vertical Electrical Motor	Electric Close Coupled Motors	Vertical Electrical Motor
APPLICATIONS	Water and Clear Liquids	Water and Clear Liquids	Water and Clear Liquids	Water and Clear Liquids
TEMPERATURE	5°F (-15°C) to 248°F (120°)	5°F (-15°C) to 248°F (120°)	up to 225°F (107°C)	up to 225°F (107°C)
CONSTRUCTION MATERIAL	#304 Stainless Steel Optional #316 S/S	Cast Iron as Standard, or Stainless Steel #304 & #316	#304 Stainless Steel	#304 Stainless Steel

					
	Shell and Tube Heat Exchangers		Plate and Frame Heat Exchangers	Brazed Heat Exchangers	
SERIES	"W"	"S"	"FFW" AHRI	"BR"	IQP1000 / ACH550
TYPE	Water to Water / Glycol to Water	Steam to Water	Steam to Water Water to Water Glycol to Water	Steam to Water Water to Water Glycol to Water	VFD Flo Fab's Preferred* 200-240V / 3-Phase 380-480V / 3-Phase 500-600V / 3-Phase
CAPACITIES	up to 3000 USGPM 681 m ³ /hr up to 250 PSI (1724 kPa) Steam		up to 10000 USGPM 2271 m ³ /hr up to 250 PSI (1724 kPa) Steam	up to 400 USGPM 91 m ³ /hr up to 150 lbs Steam	150% for 60 sec. (HD), 120% for 60 sec. (ND)
PRESSURE	150 PSI (1034 kPa) 250 PSI (1724 kPa)		300 PSI (2068 kPa)	300 PSI (up to 2068 kPa)	
APPLICATIONS	Water, Glycol or Steam		Water, Glycol or Steam	Water, Glycol or Steam	
TEMPERATURE	up to 300°F (144°C)		up to 300°F (144°C)	up to 300°F (144°C)	
CONSTRUCTION MATERIAL	Carbon Steel or Stainless Steel with Stainless Steel Tubes		Carbon Steel, Titanium and Stainless Steel. Other materials available	Titanium and Stainless Steel. Other materials available	

					
SERIES	SEP	ADSR/AD	RDT/BT	RLU / RWU	RSE
TYPE	Vortex - Tangential Air Separator (With or Without Strainer)	In-Line Air/Dirt Separator (With Strainer)	Non Replaceable Bladder Expansion Tank Replaceable Bladder Exp. Tank (with bottom system connection)	Hot Water Storage Tank with Heater	Hot Water Storage Tank
CAPACITIES	56 to 67000 USGPM (13 to 15217 m ³ /hr)	69 to 12100 USGPM (16 to 2748 m ³ /hr)	3 to 3962 Gallons (11 to 15000 litres)	100 to 15000 Gallons (379 to 56781 litres)	
CONNECTIONS	2" to 36" Diameter (50 mm to 914 mm)	2" to 36" Diameter (50 mm to 914 mm)	1" to 3" 25 mm to 75 mm	As Requested	
PRESSURE	up to 250PSI (1724 kPa)	up to 250PSI (1724 kPa)	up to 250PSI (1724 kPa)	up to 250PSI (1724 kPa)	
TEMPERATURE	up to 550°F (288°C)	up to 550°F (288°C)	up to 240°F (115°C)	up to 550°F (288°C)	
CONSTRUCTION MATERIAL	Carbon Steel or Stainless Steel	Carbon Steel or Stainless Steel	Carbon Steel EPDM	Carbon Steel or Stainless Steel	

Quotation Requirement What we need? for Skid

- 1.1 System PID
- 1.2 Pumps, Tanks and Heat Exchangers Schedule
- 1.3 Cut sheets for non Flo Fab parts such as Boilers, Chillers, etc...
- 1.4 Skids footprint
- 1.5 Mechanical room footprint
- 1.6 Control sequence details



Quality Control

All pumps are factory tested and certified performance test is available when requested by the consultant. Test facilities up to 400 HP with 27,000-gallon test bench with calibrated instruments.

Skid Advantages

- Solution for both: New construction and Retrofit.
- Easily add more modules for future expansion.
- One single point of Responsibility / Contact.
- One single submittal for approval vs. individual submittals for each component.
- Financial: Cost reduction. Effectively reduce total cost of ownership for all project stakeholders (Contractor / Consultant Engineer / End User)
- Financial: Space saving due to optimized space utilisation.
- Financial: Time (Cost) saving : Skid built in parallel during building construction, also .
- Financial: Cash flow
- Management: One single invoice / payment for all works
- Financial: Overhead savings, including project management, logistical coordination, insurance expense, etc.

PID:

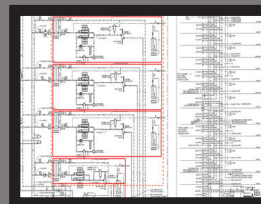

Production:



Package:

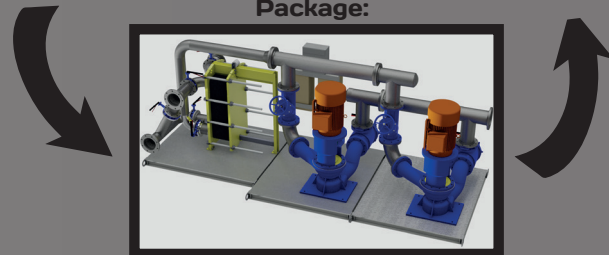

2.1 Heating and Cooling Systems

2.2 HC Module will be composed of two pumps, control panel VFD, expansion tank, air separator, chemical pot feeder, and glycol fill system (optional), balancing valves, isolation valves, air vents and drain connections, multifunction valves, suction diffusers or Y strainers, interconnecting black steel schedule 40 piping. All package components are mounted on a structural steel base with lifting lugs.

SPECS example:

Product	Product Type	Section(s)	Date Submitted	Status
XRI	Separately Coupled, Horizontally Mounted, In-Line Centrifugal Pumps	232123-HYDRONIC PUMPS	1/5/2016	Submitted View Details
880RI	Separately Coupled, Vertically Mounted, In-Line Centrifugal Pumps	232123-HYDRONIC PUMPS	1/5/2016	Submitted View Details
2000	Separately Coupled, Base-Mounted, End-Suction Centrifugal Pumps	232123-HYDRONIC PUMPS	1/5/2016	Submitted View Details

- Financial: No surplus or extra components left after fabrication by contractor.
- Time (Cost) saving: No construction delay due to tested = site plug & play
- Safety: Avoid unpleasant site safety incidents and lost days as we tremendously minimize job site man-hours.



FFBP33 & FFBP50

Discharge: 1½" NPT, female, vertical.

Spherical solids handling: 1/2"

HP: 0.3 & 0.5

RPM: 3500

Impeller: 10 vane vortex, with vanes on back side, dynamically balanced. Cast iron ASTM A-48, class 30.

Shaft: 416 series stainless steel.

Motor: NEMA L, single phase, permanent split capacitor, 120 volts, 60 Hz, oil filled, with overload protection in motor.

Pump operation: automatic float switch or automatic vertical float switch.



FF2AHS

Discharge: 2" NPT, vertical.

Spherical solids handling: 1/2"

HP: 1

RPM: 3500

Impeller: 8 vane, open, semi-vortex.

Hytrel® thermoplastic elastomer.

Shaft: 410 series stainless steel.

Motor: dry type submersible motor, 1 & 3 phase, 115 & 230 volts, 60 Hz, 3500 RPM.

For continuous duty, with thermal protector IP68 in winding, insulation class B.



FFBPEV512

Discharge: 2" NPT, female, vertical.

Spherical solids handling: 3/4"

HP: 0.5

RPM: 3500

Impeller: vortex, dynamically balanced.

Cast iron ASTM A-48, class 30. ISO G6.3

Shaft: 416 series stainless steel.

Motor: NEMA L, single phase, permanent split capacitor, 115 volts, 60 Hz, oil filled, with overload protection in motor.



FFBPSTEP

Discharge: 2" NPT, vertical.

Spherical solids handling: 3/4"

HP: 0.5 & 1

RPM: 3500

Impeller: single vane enclosed.

Polypropylene with stainless steel insert.

Shaft: stainless steel.

Motor: NEMA L, single phase, permanent split capacitor, 115/230 volts, 60 Hz, oil filled, class B insulation, with overload protection in motor.



FF2BEH-SS

Discharge: 2" NPT, vertical.

Spherical solids handling: 3/4"

HP: 0.5 & 1

RPM: 3500

Impeller: 2 vane, open, with vanes on back side, dynamically balanced ISO G6.3. Bronze 85-5-5-5.

Shaft: stainless steel.

Motor:

Single phase: NEMA L, permanent split capacitor, 115/230 volts, oil filled, with overload protection in motor.

Three phase: NEMA B, 208/230 & 460 volts, oil filled. Requires overload protection to be included in control panel.



FF2BSE411 & FF2BSE511

Discharge: 2" NPT, vertical.
 Spherical solids handling: 2"
 HP: 0.4 & 0.5
 RPM: 1750
 Impeller: open, double vane, dynamically balanced.
 Cast iron ASTM A-48, class 30, ISO G6.3.
 Shaft: 416 series stainless steel.
 Motor: NEMA L, single phase, permanent split capacitor, 115 volts, 60 Hz, oil filled, with overload protection in motor.



FF2SEV512

Discharge: 2" NPT, female, vertical.
 Spherical solids handling: 2"
 HP: 0.5
 RPM: 3500
 Impeller: vortex. Cast iron ASTM A-48, class 30, ISO G6.3.
 Shaft: 416 series stainless steel.
 Motor: NEMA L, single phase, permanent split capacitor, 115 volts, 60 Hz, oil filled, with overload protection in motor.



FF2BSE-SS / FF3BSE-SS

Discharge: 2" or 3" NPT female, vertical, bolt on flange. Includes both flanges.
 (The name of the pump changes to FF3BSE when used with the 3" discharge flange.)
 Spherical solids handling: 2"
 HP: 0.5 & 0.75
 RPM: 1750
 Impeller: 2 vane, open, with vanes on back side.
 Cast iron ASTM A-48, class 30.
 Shaft: 416 series stainless steel.
 Motor: NEMA L, single phase, permanent split capacitor, 120 volts, 60 Hz, oil filled, with overload protection in motor.



FF3BSE-SS / 1 HP

Discharge: 3" NPT, female, vertical, bolt on flange.
Spherical solids handling: 2"

HP: 1

RPM: 1750

Impeller: 2 vane, open, with vanes on back side.

Cast iron ASTM A-48, class 30.

Shaft: 416 series stainless steel.

Motor:

Single phase: NEMA L, permanent split capacitor, 230 volts, 60 Hz, oil filled, with overload protection in motor.

Three phase: NEMA B, 230/460 volts, 60 Hz, oil filled. Requires overload protection to be included in control panel.



FF3BSE-SS / 1.5 & 2 HP

Discharge: 3" NPT, female, vertical, bolt on flange.
Spherical solids handling: 2½"

HP: 1.5 & 2

RPM: 1750

Impeller: 2 vane, open, with vanes on back side.

Cast iron ASTM A-48, class 30.

Shaft: 416 series stainless steel.

Motor:

Single phase: NEMA L, permanent split capacitor, 230 volts, 60 Hz, oil filled, with overload protection in motor.

Three phase: NEMA B, 230/460 volts, 60 Hz, oil filled. Requires overload protection to be included in control panel.



FF3BSE-SS / 3 HP

Discharge: 3" NPT, female, vertical, bolt on flange.
 Spherical solids handling: 2½"
 HP: 3
 RPM: 1750
 Impeller: 2 vane, open, with vanes on back side.
 Cast iron ASTM A-48, class 30.
 Shaft: 416 series stainless steel.
 Motor:
 Single phase: permanent split capacitor, 230 volts, 60 Hz, oil filled, with overload protection in motor.
 Three phase: 230/460 volts, 60 Hz, oil filled.
 Requires overload protection to be included in control panel.



FF3BWSE-DS

Discharge: 3", 125 lb, flange horizontal.
 Spherical solids handling: 2½"
 HP: 2-5
 RPM: 1750
 Impeller: 2 vane, semi-open, with vanes on back side. Cast iron ASTM A-48, class 30.
 Shaft: 416 series stainless steel.
 Motor: NEMA B, three phase, 230 & 460 volts, 60 Hz, oil filled, with class F insulation.
 Requires overload protection to be included in control panel.



FF4BSE-SS

Discharge: 4" NPT vertical.
 Spherical solids handling: 3"
 HP: 3 & 5
 RPM: 1750
 Impeller: 2 vane, open, with vanes on back side.
 Cast iron ASTM A-48, class 30.
 Shaft: 416 series stainless steel.
 Motor: NEMA B, three phase, 230/460 volts, 60 Hz, oil filled, with class F insulation.
 Requires overload protection to be included in control panel.



FF4BWSE-DS

Discharge: 4", 125 lb, flange horizontal.

Spherical solids handling: 3"

HP: 2-7.5

RPM: 1750

Impeller: 2 vane, open, with vanes on back side.

Cast iron ASTM A-48, class 30.

Shaft: 316 series stainless steel.

Motor: NEMA B, three phase, 230 & 460 volts, 60 Hz, oil filled, with class F insulation.

Requires overload protection to be included in control panel.



FF4BSE-DS

Discharge: 4", 125 lb, flange horizontal.

Spherical solids handling: 3"

HP: 4.5-15

RPM: 1750

Impeller: 2 vane, open, with vanes on back side.

Cast iron ASTM A-48, class 30.

Shaft: 416 series stainless steel.

Motor:

Single phase: NEMA L, permanent split capacitor, 230 volts, 60 Hz, oil filled.

Three phase: NEMA B 230/460 volts, 60 Hz, oil filled.



FF4BSE-HLDS

Discharge: 4", 125 lb, flange horizontal.

Spherical solids handling: 3"

HP: 7.5-15

RPM: 1750

Impeller: 2 vane, closed, with vanes on back side.

Cast iron ASTM A-48, class 30.

Shaft: 416 series stainless steel.

Motor: NEMA B, three phase, 230/460 volts, 60 Hz, oil filled. Requires overload protection to be included in control panel.



FF6BSE-LDS / 9-30 HP

Discharge: 6", 125 lb, flange horizontal.
 Spherical solids handling: 4"
 HP: 9-30
 RPM: 1150
 Impeller: 1 vane, closed, with vanes on back side.
 Cast iron ASTM A-48, class 30.
 Shaft: 416 series stainless steel.
 Motor: NEMA B, three phase, 230/460 volts, 60 Hz, oil filled. Requires overload protection to be included in control panel.



FF6BSE-LDS / 18-60 HP

Discharge: 6", 125 lb, flange horizontal.
 Spherical solids handling: 4"
 HP: 18-60
 RPM: 1750
 Impeller: 1 vane (2 vane for 48 & 60 HP), closed, with vanes on back side. Cast iron ASTM A-48, class 30.
 Shaft: 416 series stainless steel.
 Motor: NEMA B, three phase, 230/460 volts, 60 Hz, oil filled. Requires overload protection to be included in control panel.



FF6BSE-HLDS

Discharge: 6", 125 lb, flange horizontal.
 Spherical solids handling: 3"
 HP: 30-60
 RPM: 1750
 Impeller: 3 vane, closed, with vanes on back side.
 Cast iron ASTM A-48, class 30.
 Shaft: 416 series stainless steel.
 Motor: NEMA B, three phase, 230/460 volts, 60 Hz, oil filled. Requires overload protection to be included in control panel.



FF8BSE-HLDS

Discharge: 8", 125 lb, flange horizontal.

Spherical solids handling: 3"

HP: 36-48

RPM: 1150

Impeller: 3 vanes, closed, with a bronze wear ring and vanes on back side. Cast iron ASTM A-48, class 30.

Shaft: 416 series stainless steel.

Motor: NEMA B, three phase, 230/460 volts, 60 Hz, oil filled. Requires overload protection to be included in control panel.

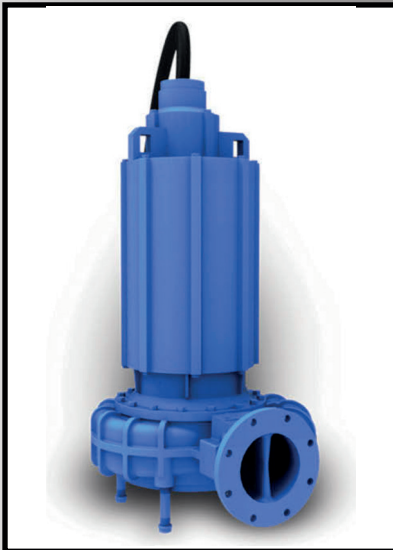

FF8BSE-HADS

Discharge: 8", 125 lb, flange horizontal.

Spherical solids handling: 3"

HP: 30-75 / 100-200

RPM: 1150 / 3450

Impeller: 3 vane, closed, with with a bronze wear ring and vanes on back side. Cast iron ASTM A-48, class 30.

Shaft: 416 series stainless steel.

Motor: NEMA B, three phase, 230/460 volts, 60 Hz, air cooled. Explosion proof, class 1, division 1, group C & D. Requires overload protection to be included in control panel.



FF4XBSE W/ EXPLOSION PROOF MOTORS

Discharge: 4", 125 lb, flange horizontal.
Spherical solids handling: 3"
HP: 5-20
RPM: 1150 & 1750
Impeller: 2 vane, open, with vanes on back side.
Cast iron ASTM A-48 class 30.
Shaft: 416 series stainless steel.
Motor: NEMA B, three phase, 230 & 460 volts, 60 Hz, 1150 & 1750 RPM, air cooled. Explosion Proof, Class 1, Division 1, Group C & D, insulation Class F. Requires overload protection to be included in control panel.



FF6XBSE W/ EXPLOSION PROOF MOTORS

Discharge: 6", 125 lb, flange horizontal.
Spherical solids handling: 4"
HP: 15-75
RPM: 1150 & 1750
Impeller: 1 vane, closed, with vanes on back side.
Cast iron ASTM A-48 class 30.
Shaft: 416 series stainless steel.
Motor: NEMA B, three phase, 230 & 460 volts, 60 Hz, 1150 & 1750 RPM, air cooled. Explosion Proof, Class 1, Division 1, Group C & D, insulation Class F. Requires overload protection to be included in control panel.



FF8XBSE W/ EXPLOSION PROOF MOTORS

Discharge: 8", 125 lb, flange horizontal.
Spherical solids handling: 3"
HP: 30-150
RPM: 1150 & 1750
Impeller: 3 vane, closed, with with a bronze wear ring and vanes on back side. Cast iron ASTM A-48, class 30.
Shaft: 416 series stainless steel.
Motor: NEMA B, three phase, 460 volts, 60 Hz, 1150 & 1750 RPM, air cooled. Explosion Proof, Class 1, Division 1, Group C & D, insulation Class F. Requires overload protection to be included in control panel.



FFBGP-DS / 2 HP

Discharge: 1¼" NPT, vertical.

HP: 2

RPM: 3500

Impeller: 12 vanes, vortex with vanes on back side, dynamically balanced. Cast iron ASTM A-48, class 30.
Radial cutter and shredding ring: hardened 440C, stainless steel, hardness Rockwell C-55.

Shaft: 420 series stainless steel.

Motor:

Single phase: permanent split capacitor, 220 volts, 60 Hz, oil filled, with overload protection in motor. Class F insulation.

Three phase: 220/440 volts, 60 Hz, oil filled with overload protection in motor. Class F insulation.



FFBGP-DS / 3, 5 & 7.5 HP

Discharge: 2" NPT, vertical.

HP: 3, 5 & 7.5

RPM: 3500

Impeller: 10 vanes, vortex with vanes on back side, dynamically balanced. Cast iron ASTM A-48, class 30.
Radial cutter and shredding ring: hardened 440C, stainless steel, hardness Rockwell C-55.

Shaft: 420 series stainless steel.

Motor:

Single phase: NEMA L, permanent split capacitor (to be located in control panel), 230 volts, 60 Hz, oil filled. Class F insulation.

Three phase: NEMA B, 230/460 volts, 60 Hz, oil filled. Class F insulation. Requires overload protection to be included in control panel.



FFBGPH-DS / 3, 5 & 7.5 HP

Discharge: 2½" flange, horizontal.

HP: 3, 5 & 7.5

RPM: 3500

Impeller: 10 vanes, vortex with vanes on back side, dynamically balanced. Cast iron ASTM A-48, class 30.
Radial cutter and shredding ring: hardened 440C, stainless steel, hardness Rockwell C-55.

Shaft: 420 series stainless steel.

Motor:

Single phase: NEMA L, permanent split capacitor (to be located in control panel), 230 volts, 60 Hz, oil filled. Class F insulation.

Three phase: NEMA B, 230/460 volts, 60 Hz, oil filled. Class F insulation. Requires overload protection to be included in control panel.



FFBVRI

Discharge: 2" & 3" NPT elbow, vertical.

Spherical solids handling: 1½" & 2"

HP: 0.5 - 7.5

RPM: 3500

Impeller: 8 vane, semi-open Vortex. 316 series stainless steel.

Shaft: 416 series stainless steel.

Motor: For continuous duty, 1 & 3 phase, 3450 RPM, dry type, insulation class B, protection IP68, 115/230 volts.



FFBVRI

Discharge: 2.5" & 3" NPT elbow, vertical.

Spherical solids handling: 2½" & 3"

HP: 1.5 - 3

RPM: 3450

Impeller: 6 & 8 vane, semi-open Vortex.

Cast iron ASTM A-48, class 30.

Shaft: 410 series stainless steel.

Motor: 1 & 3 phase, 230 volts, 60 Hz, 3450 RPM.

For continuous duty, with protection IP68 in winding, insulation class B.

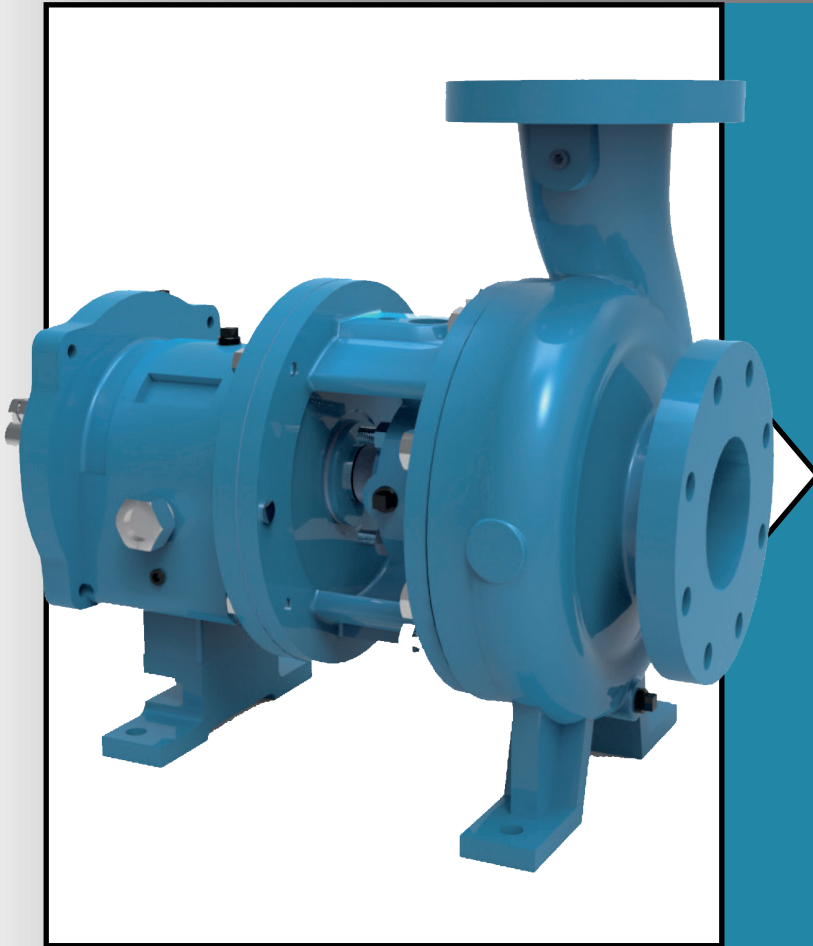

FFMCN-G CHEMICAL PROCESS PUMP

TECH DATA

- Size: 1" - 10"
- Max head: 6164GPM
- Max cap: 466'
- Media temp: -13°F ~+ 284°F
- Max System Pressure: 363PSI

ADVANTAGE

- Complies with ANSI B73.1
- Open impeller
- High efficiency & energy saving
- Wide operation range
- Robust structure
- Modern design

APPLICATION

- Chemical Engineering
- Paper and pulp
- All process industries
- Petrochemical

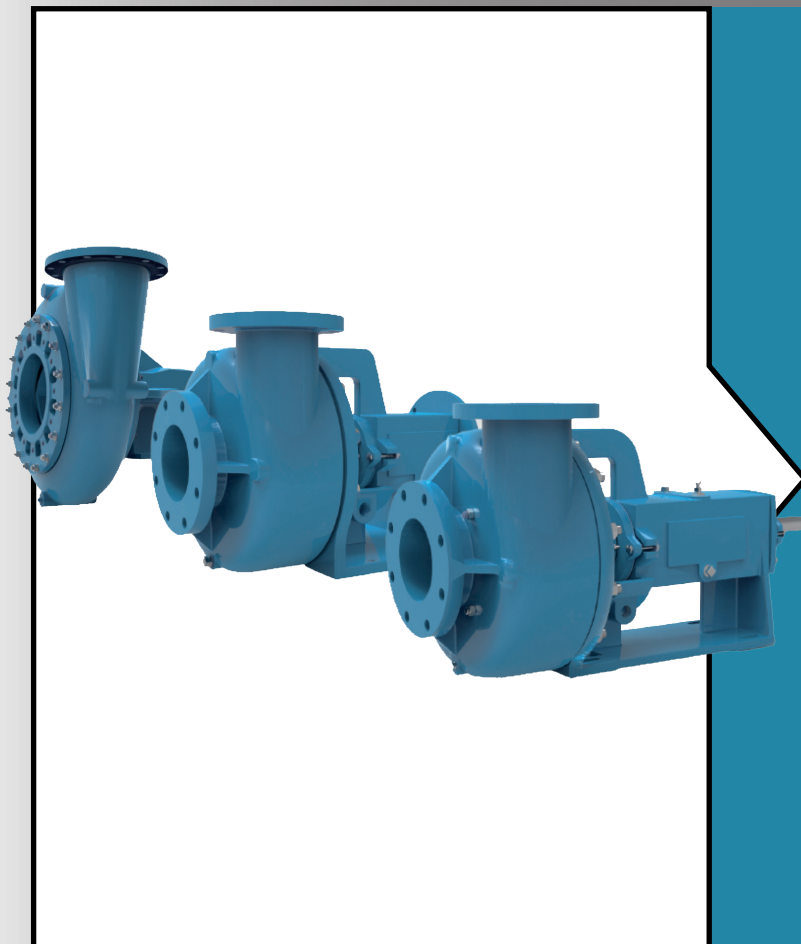

FFMCO SLURRY PUMP

TECH DATA

- Size: 2" - 12"
- Max cap: 7045GPM
- Max head: 361' '
- Media temp: -13°F ~+ 284°F
- Max system pressure: 232PSI

ADVANTAGE

- Semi-open impeller
- Robust design
- Wide operation range
- Heavy duty bearing housing

APPLICATION

- Barite & mineral oil based drilling
- Bentonite, Salt water slurry
- Cement
- Paper and pulp, Mine dewatering
- Lime, Gypsum, Calcium,
- Ash & coal liquid slurry
- Chemical industry

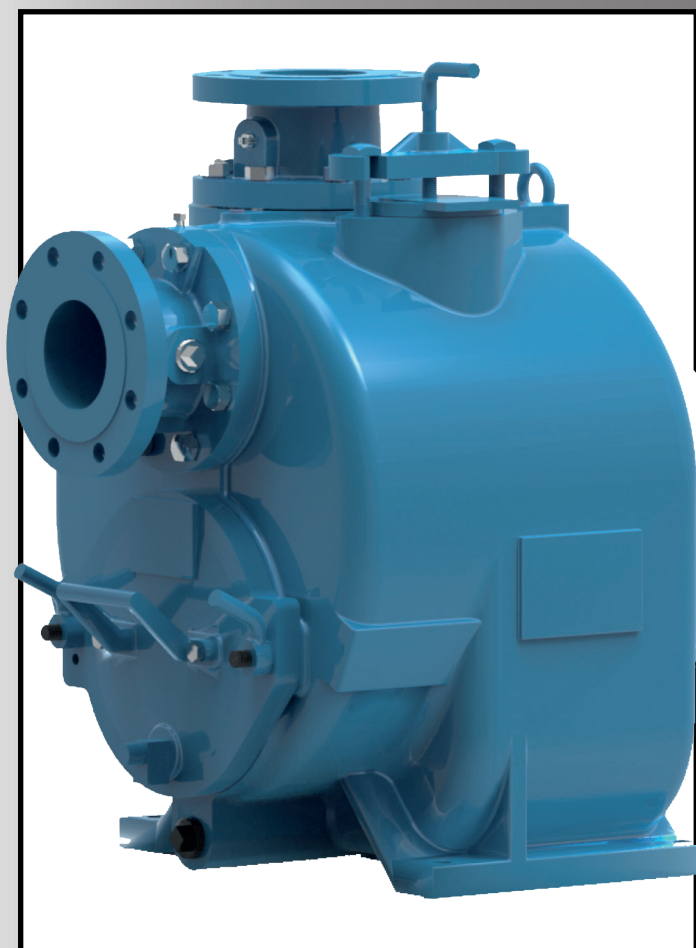

FFMCT SELF PRIMING TRASH PUMP

TECH DATA

- Size: 2"- 12"
- Max cap: 3400GPM
- Max head: 130'
- Media temp: 14°F ~+ 185°F
- Max system pressure: 51PSI
- Max suction: 25'
- Max solids: 3"

ADVANTAGE

- Proven design
- Excellent performance
- Non-clogging design
- Excellent self priming function
- Installation and maintenance

APPLICATION

- Municipal
- Marine
- Industrial sewage water treatment
- Agriculture irrigation
- Drainage/Construction



FFMCST SELF PRIMING TRASH PUMP

TECH DATA

- Size: 2"- 12"
- Max cap: 3400GPM
- Max head: 130'
- Media temp: 14°F ~+ 185°F
- Max system pressure: 51PSI
- Max suction: 25'
- Max solids: 3"

ADVANTAGE

- Proven design
- Excellent performance
- Non-clogging design
- Excellent self priming function
- Installation and maintenance

APPLICATION

- Municipal
- Marine
- Industrial sewage water treatment
- Agriculture irrigation
- Drainage/Construction

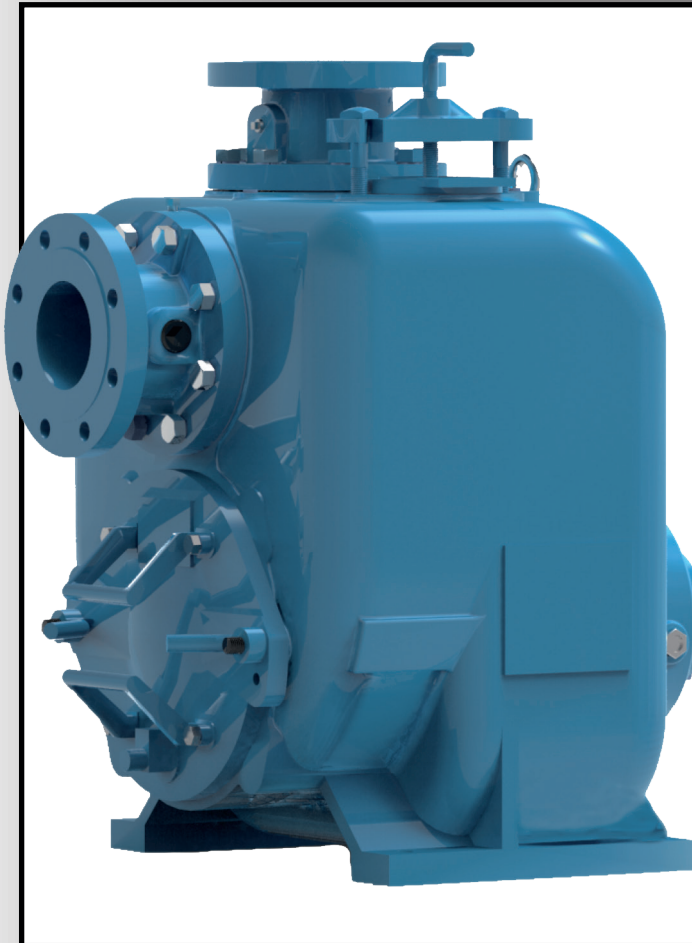

FFMCU HIGH HEAD SELF PRIMING TRASH PUMP

TECH DATA

- Size: 3" - 6"
- Max cap: 1500GPM
- Max head: 207'
- Media temp: 14°F ~+ 185°F
- Max system pressure: 87PSI
- Max suction: 25'
- Max solids: 1.25"

ADVANTAGE

- Proven design
- Excellent & reliable performance
- Non- clogging design
- Excellent self priming function
- Installation and maintenance
- Excellent trash handling capability

APPLICATION

- Municipal
- Marine
- Industrial sewage water treatment
- Agriculture irrigation

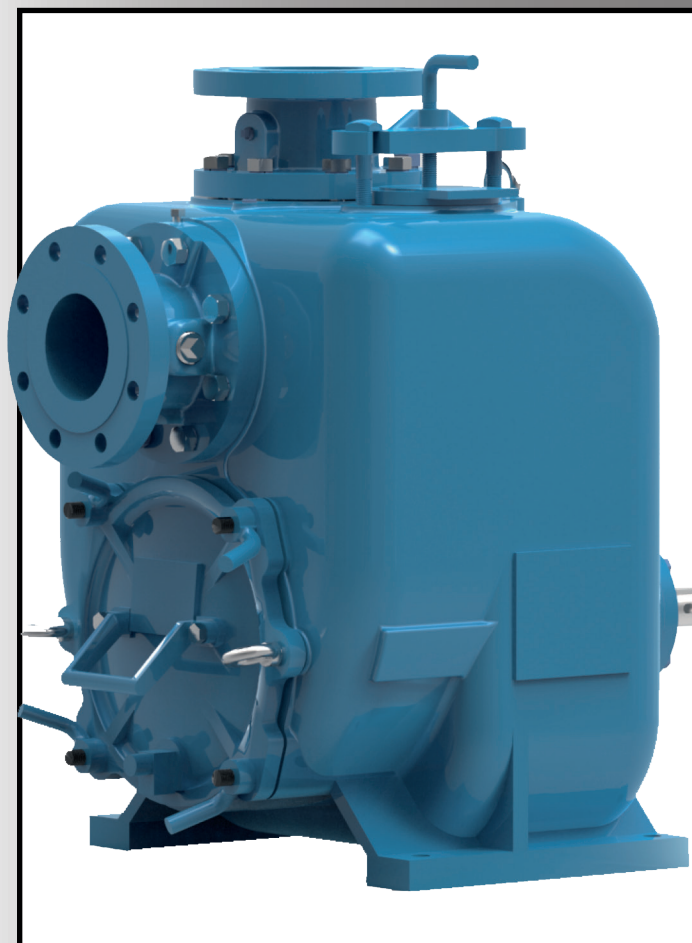

FFMCSU HIGH HEAD SELF PRIMING TRASH PUMP

TECH DATA

- Size: 3" - 6"
- Max cap: 1500GPM
- Max head: 207'
- Media temp: 14°F ~+ 185°F
- Max system pressure: 87PSI
- Max suction: 25'
- Max solids: 1.25"

ADVANTAGE

- Proven design
- Excellent & reliable performance
- Non- clogging design
- Excellent self priming function
- Installation and maintenance
- Excellent trash handling capability

APPLICATION

- Municipal
- Marine
- Industrial sewage water treatment
- Agriculture irrigation

Typical Mechanical Room

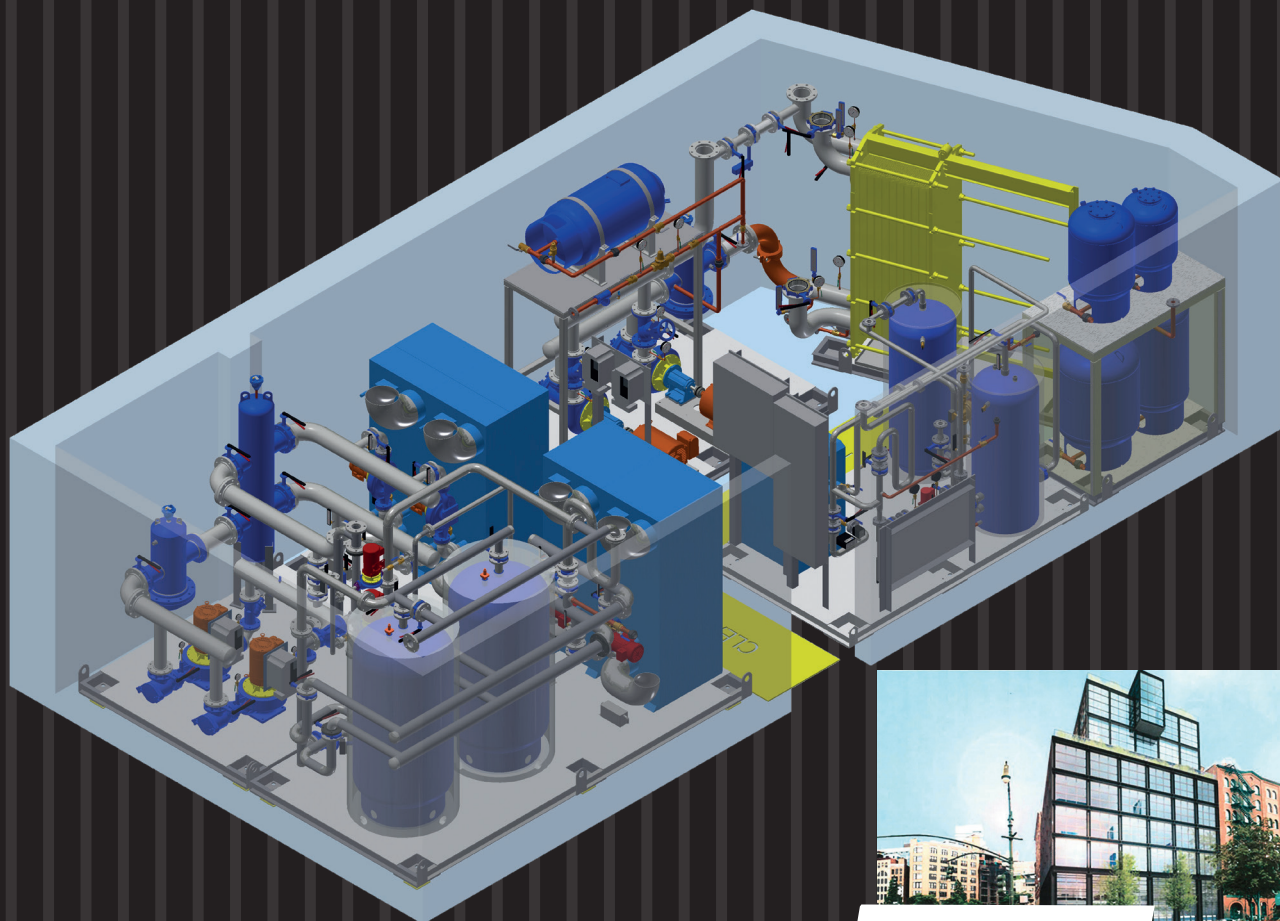
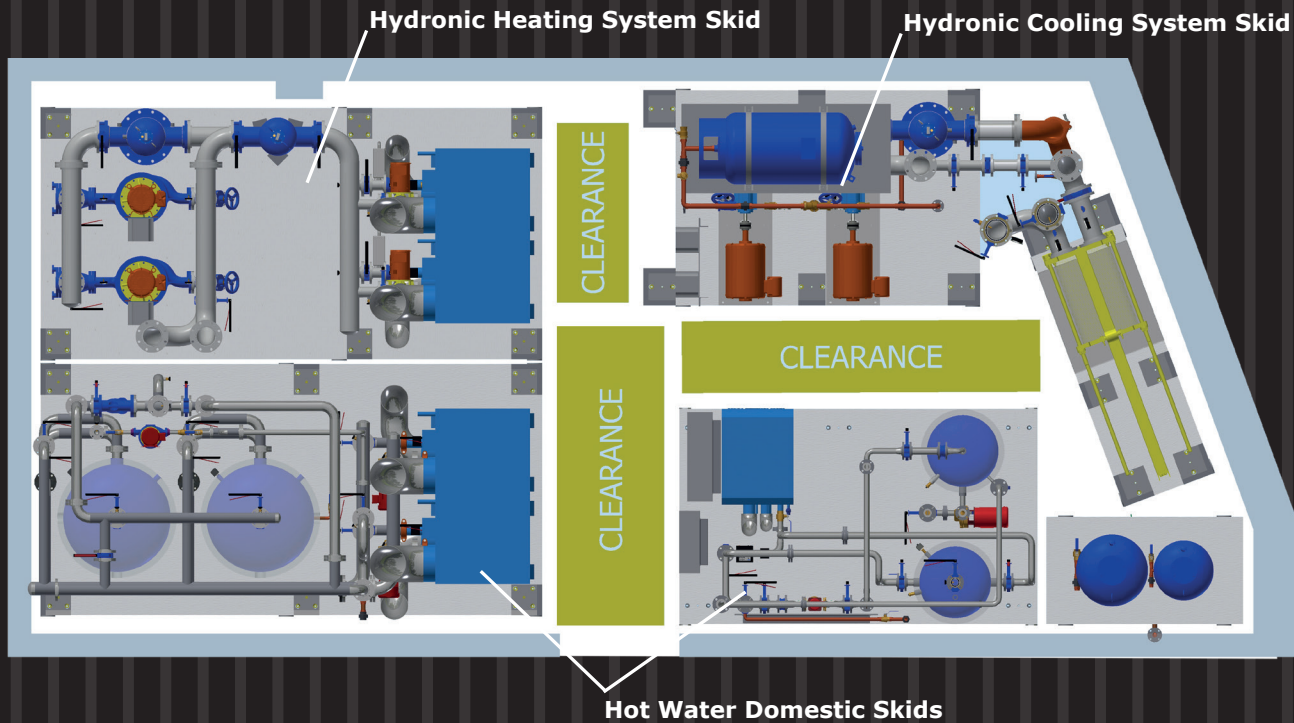

POD HOTEL, NEW YORK,
UNITED-STATES

FLEXIBLE - ST

Material: Steel and Stainless Steel
 Pressure: 475 PSIG at 850°F with water
 Size Range: 1/2" to 2"
 Connections: Threaded



AIR VENT - MV

Material: Cast Iron
 Pressure: MV15 150 PSIG at 345°F
 MV15 300 PSIG at 400°F
 Size Range: 3/4"
 Connections: Threaded



PRESSURE AND OR TEMPERATURE PORTS

Material: Bronze
 Pressure: 1000 PSIG at 140°F
 Size Range: 1/4"
 Connections: SS2501: Threaded
 SS2511: Threaded
 Extended

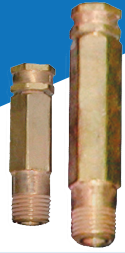

UNION ARCH FLEXIBLE - DUT

Material: Steel Union and EPDM
 Pressure: 214 PSIG at 250°F with water
 Size Range: 1/2" to 12"
 Connections: Threaded Double



AIR VENT - AA

Material: Brass
 Pressure: 150 PSIG at 200°F
 Size Range: 1/8" and 1/4"
 Connections: Threaded



WAFER CHECK VALVE - LSDDB

Material: Cast Iron Body, Stainless Steel
 Disc, EPDM Seat
 Pressure: 175 PSIG at 225°F up to 12"
 150 PSIG at 250°F
 from 14" to 24"
 Size Range: 2" to 24"
 Body Style: Wafer



STANDARD FLANGED CONNECTOR - SM

Material: Steel and Stainless Steel
 Pressure: 125 PSIG at 450°F with water
 Size Range: 2" to 16"
 Body Style: Flanged



BUTTERFLY VALVE - BFVZ - L

Material: Cast Iron Body, Stainless Steel
 Disc, EPDM Seat
 Pressure: 175 PSIG at 225°F up to 12"
 150 PSIG at 250°F
 from 14" to 24"
 Size Range: 2" to 24"
 Body Style: Lug



SUCTION DIFFUSER - ASDFF

Material: Cast Iron Body, Stainless Steel Screen
 Pressure: 175 PSIG at 250°F with water
 200 PSIG at 150°F with steam
 Size Range: 2" to 20"
 Connections: Flanged



SINGLE ARCH FLEXIBLE - SSP & DSP

Material: Steel Flanged and EPDM
 Pressure: 214 PSIG at 240°F with water
 Size Range: 1 1/2" to 14"
 Connections: SSP Flanged Single
 DSP Flanged Double



MULTIFUNCTION VALVE - MFV

Material: Ductile Iron and Stainless Steel Disc
 Pressure: 150 PSIG at 225°F
 Size Range: 2" to 18"
 Connections: MFV-F: Flanged





2000 - FIXED BLADDER EXPANSION TANK

Capacities: 2 to 132 Gallons (8 to 528 liters)
 Pressure: up to 150PSI (1034kpa)
 Temperature: up to 200°F (93°C)
 Materials: Carbon Steel, Butyl

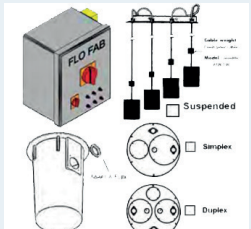

						
SERIES	LB-25, 40,75, 215 & 315	FS-237, 337 & 437, 475, 675, 4110, 6110, 8110	LBV-40	LBV-75, 215 & 315	LBK-75	LBK-215 & 315
TYPE	Effluent Pump	Multi-Purpose Drainage Pump	Effluent & Sewage Vortex Pump		Effluent	Sewage Non Clog Pump
CAPACITIES	up to 175 USGPM (40 m ³ /hr)	up to 1400 USGPM (317 m ³ /hr)	up to 159 USGPM (36 m ³ /hr)		up to 185 USGPM (42 m ³ /hr)	
HEAD	8 to 72 ft. (2.4 to 21.5 m)	10 to 163 ft. (3 to 49 m)	4 to 59 ft. (1.2 to 18m)		10 to 59 ft. (3 to 18m)	
SOLID SIZE	3/8" (9 mm)	3/4" (19 mm)	3/4" (19mm)	2" (50mm)	3/4" (19mm)	2" (50mm)
HORSEPOWER	up to 1 HP (0.75 kW)	up to 30 HP (22 kW)	up to 1 HP (0.75 kW)		up to 1 HP (0.75 kW)	
DRIVES	Air Filled Electrical Motors Explosion Proof	Air Filled Electrical Motors Explosion Proof	Air Filled Electrical Motors Explosion Proof		Air Filled Electrical Motors Explosion Proof	
APPLICATIONS	Water	Water	Water, Sewage & Waste Liquids		Water	Water & Waste Liquids
TEMPERATURE	up to 200°F (94 °C)	up to 200°F (94 °C)	up to 200°F (94 °C)		up to 200°F (94 °C)	
CONSTRUCTION MATERIALS	Cast Iron	Cast Iron and Stainless Steel	Cast Iron		Cast Iron	

					
SERIES	FBV-332	FBV-337 & 437	FGC-015 / FGC-022	BAF	Sub Accessories
TYPE	Sewage Non Clog Pump		Sewage Grinder Pump	Break Away Fitting	
CAPACITIES	up to 317 USGPM 72 m ³ /hr		up to 61 USGPM 14 m ³ /hr		
HEAD	8 to 66ft (2.4 to 20 m)		17 to 105ft (5.2 to 32 m)		
SOLID SIZE	2" (50 mm)	3" (80 mm)	3/4" (19 mm)		
HORSEPOWER	up to 5 HP (3.7 kW)		up to 5 HP (3.7 kW)		
DRIVES	Air Filled Electrical Motors Explosion Proof		Air Filled Electrical Motor Explosion Proof		
APPLICATIONS	Water, Sewage & Waste Liquids		Water, Sewage & Waste Liquids		
TEMPERATURE	up to 200°F (94°C)		up to 200°F (94°C)		
CONSTRUCTION MATERIAL	Cast Iron		Cast Iron	Cast Iron	

CAPACITIES	up to 30 USGPM (3.1 m ³ /hr)
HEAD	up to 692 ft. (300 PSI) (211 m)
PRESSURE	up to 300 PSI (2069 kPa)
HORSEPOWER	up to 10 HP (7.46 kW)
DRIVES	Electrical Motors
APPLICATIONS	Light Fuel Oil
TEMPERATURE	up to 150°F (65°C)
CONSTRUCTION MATERIAL	Bronze / Stainless Steel or Cast Iron

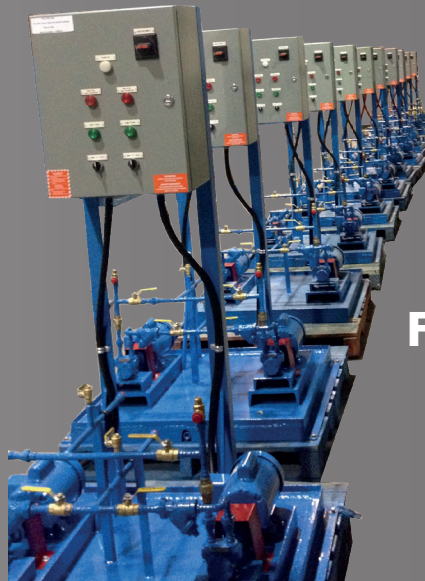

Type: D-FOM
Duplex
Fuel Oil System

CAPACITIES	up to 12000 USGPM (2725 m ³ /hr)
HEAD	up to 692 ft. (300 PSI) (211 m)
PRESSURE	up to 300 PSI (2069 kPa)
HORSEPOWER	up to 400 HP (298.3 kW)
DRIVES	Electrical Motors
APPLICATIONS	Water / Glycol
TEMPERATURE	up to 300°F (144°C)
CONSTRUCTION MATERIAL	Bronze / Stainless Steel or Cast Iron

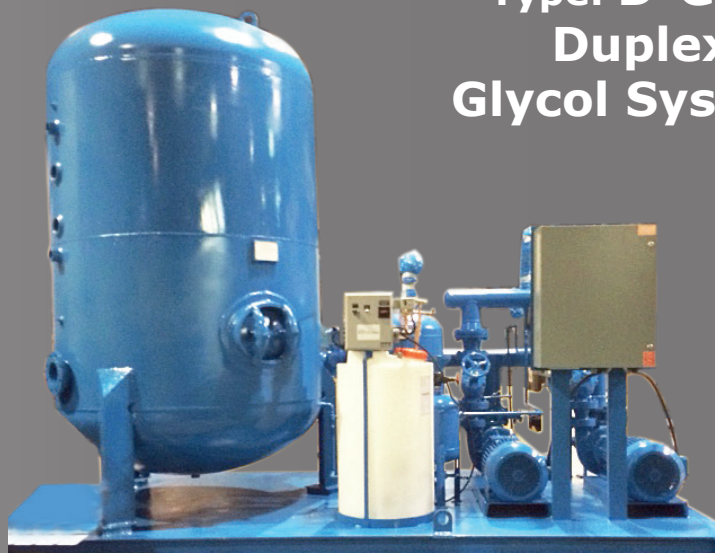

Type: D-GLY
Duplex
Glycol System

CAPACITIES	up to 12000 USGPM (2725 m ³ /hr)
HEAD	up to 692ft. (300 PSI) (211 m)
PRESSURE	up to 300 PSI (2069 kPa)
HORSEPOWER	up to 400 HP (298.3 kW)
DRIVES	Electrical Motors
APPLICATIONS	Water / Glycol
TEMPERATURE	up to 300°F (144°C)
CONSTRUCTION MATERIAL	Bronze / Stainless Steel or Cast Iron



Type: D-HC-XRI
Duplex - Package
Toronto, Canada

CAPACITIES	up to 12000 USGPM (2725 m ³ /hr)
HEAD	up to 692 ft. (300 PSI) (211 m)
PRESSURE	up to 300 PSI (2069 kPa)
HORSEPOWER	up to 400 HP (298.3 kW)
DRIVES	Electrical Motors
APPLICATIONS	Water / Glycol
TEMPERATURE	up to 300°F (144°C)
CONSTRUCTION MATERIAL	Bronze / Stainless Steel or Cast Iron



Type: D-CPS-HT Duplex - Constant Pressure System

Fresno, California

CAPACITIES	up to 12000 USGPM (2725 m ³ /hr)
HEAD	up to 692 ft. (300 PSI) (211 m)
PRESSURE	up to 300 PSI (2069 kPa)
HORSEPOWER	up to 400 HP (298.3 kW)
DRIVES	Electrical Motors
APPLICATIONS	Water / Glycol
TEMPERATURE	up to 300°F (144°C)
CONSTRUCTION MATERIAL	Bronze / Stainless Steel or Cast Iron

Type: BOI Boiler Package

San Francisco - California, USA



CAPACITIES	up to 12000 USGPM (2725 m ³ /hr)
HEAD	up to 692 ft. (300 PSI) (211 m)
PRESSURE	up to 300 PSI (2069 kPa)
HORSEPOWER	up to 400 HP (298.3 kW)
DRIVES	Electrical Motors
APPLICATIONS	Water / Glycol
TEMPERATURE	up to 300°F (144°C)
CONSTRUCTION MATERIAL	Bronze / Stainless Steel or Cast Iron

Type: CHI Chiller Package

Garden City - Texas, USA



CAPACITIES	up to 12000 USGPM (2725 m ³ /hr)
HEAD	up to 692 ft. (300 PSI) (211 m)
PRESSURE	up to 300 PSI (2069 kPa)
HORSEPOWER	up to 400 HP (298.3 kW)
DRIVES	Electrical Motors
APPLICATIONS	Water / Glycol
TEMPERATURE	up to 300°F (144°C)
CONSTRUCTION MATERIAL	Bronze / Stainless Steel or Cast Iron



**Type: LCOO
Large Cooling
Package**

Fort Bliss - Texas, USA

CAPACITIES	up to 12000 USGPM (2725 m ³ /hr)
HEAD	up to 692 ft. (300PSI) (211 m)
PRESSURE	up to 300 PSI (2069 kPa)
HORSEPOWER	up to 400 HP (298.3 kW)
DRIVES	Electrical Motors
APPLICATIONS	Water / Glycol
TEMPERATURE	up to 300°F (144°C)
CONSTRUCTION MATERIAL	Bronze / Stainless Steel or Cast Iron

**Type: HCE
Heating
Cooling with
Enclosure**

Michigan, USA

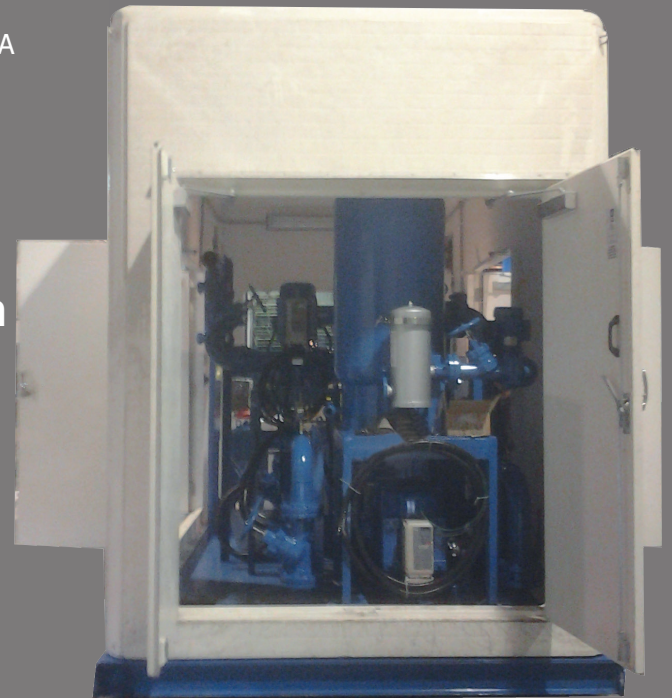

FLO FAB

Booster

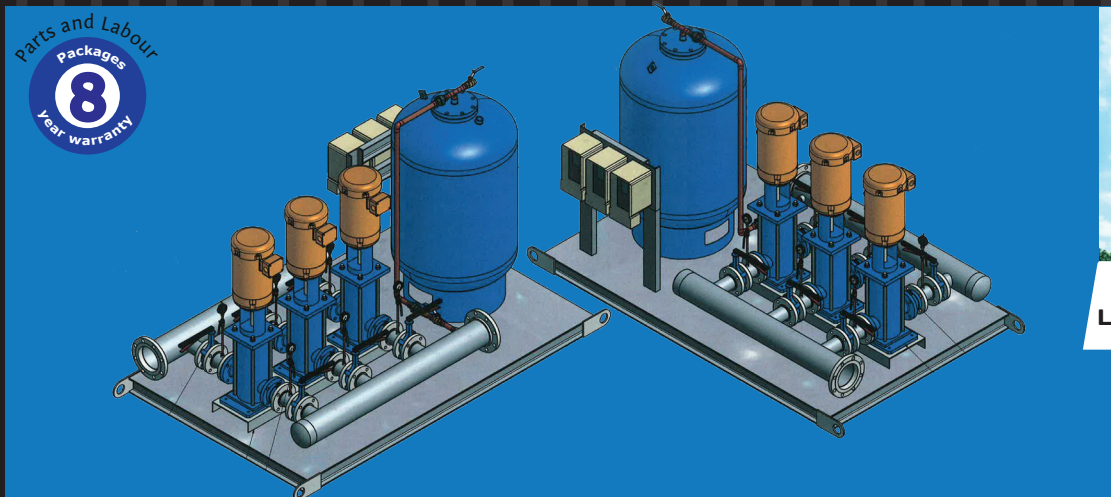

Heating or Cooling

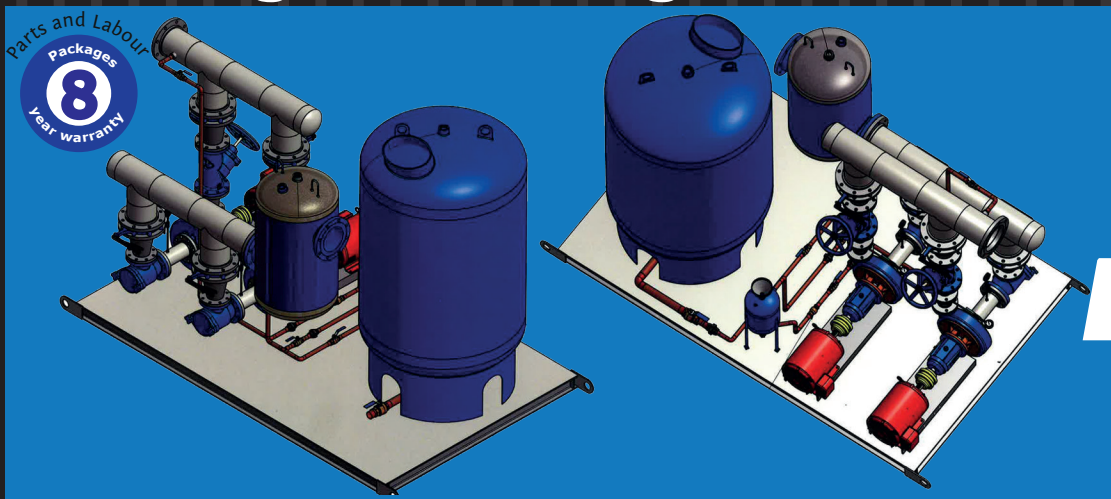

Large Cooling

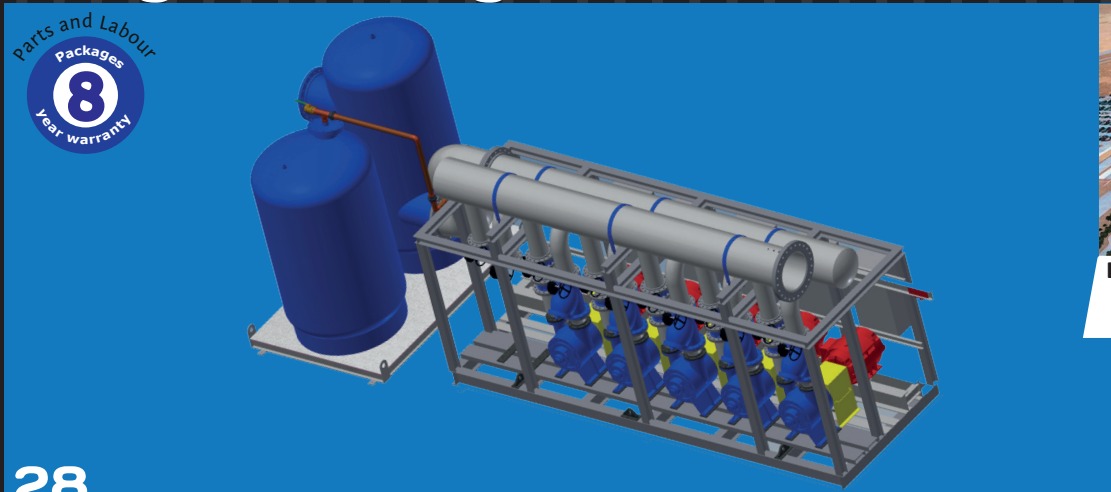

Proud pump supplier for the New World Trade Center towers in New York

AND MORE

Heat Transfer

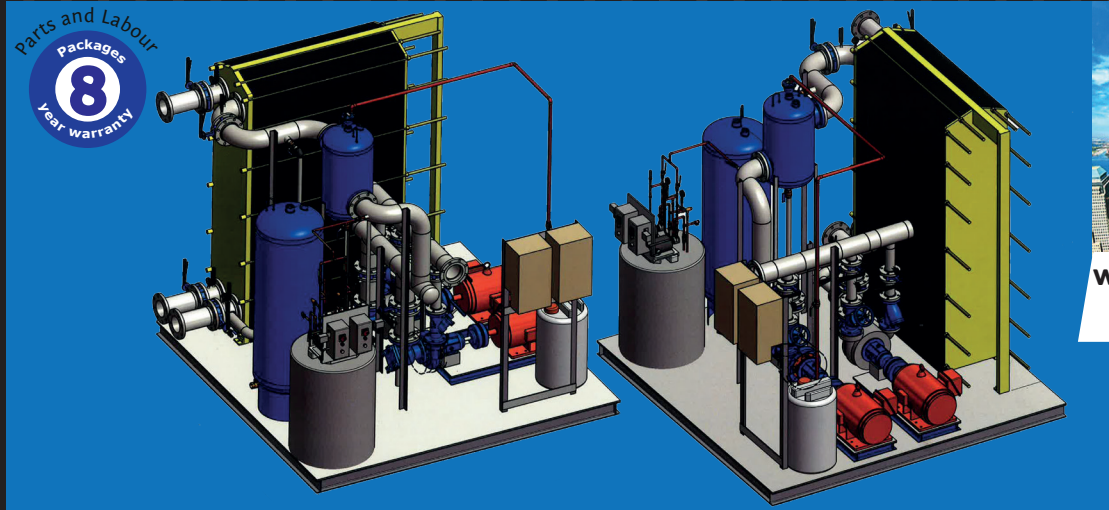

WORLD TRADE CENTER
NEW-YORK, U.S.A.

Duplex Pumps – Heating System

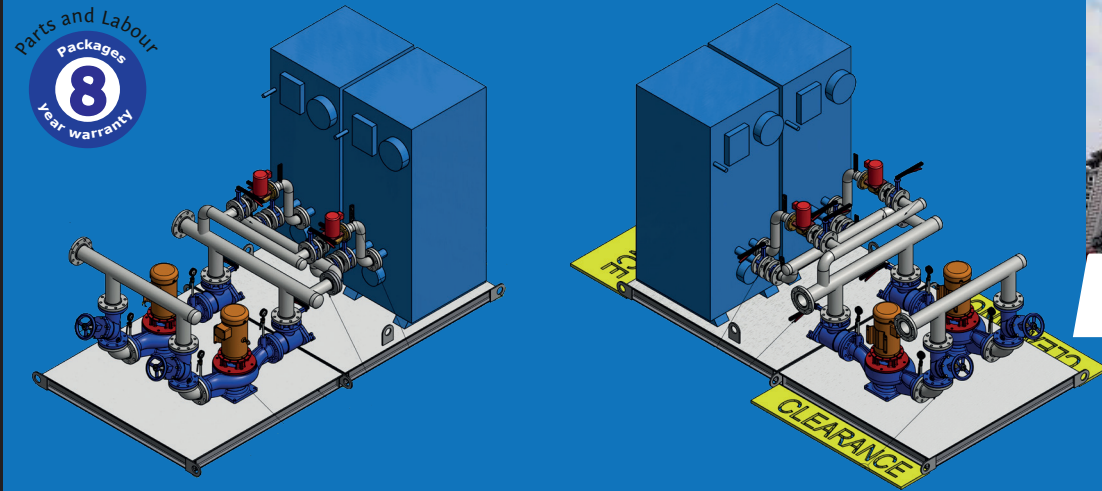

CRITERION HAGUE
NEW-YORK, U.S.A.
PHASE 1

Boiler Pack



CRITERION
NEW-YORK, U.S.A.
PHASE 2

We are a proud supplier for the following completed and ongoing projects :



Zermatt Lodge
Salt Lake City, UT, U.S.A.
<https://zermattresort.com>



Pier 17 South Street Seaport
South Street, New York, U.S.A
www.southstreetseaport.com



Pearl-Qatar
Doha, Qatar
www.thepearlqatar.com



Museum of Science and Industry
Tampa, Florida
www.mosi.org
Eng : Advance System Engineering



Exchange Tower
Vancouver, B.C., Canada
www.theexchangebuilding.ca



Dar El Salam General Hospital
Cairo Governorate, Egypt



Brock University Center
St. Catharines, Ontario, Canada
<https://www.brocku.ca>



520 Park Avenue
New York, U.S.A
www.520parkavenue.com

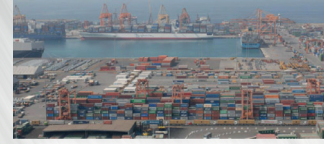

Saudi Jeddah Port
Jeddah Saudi, Arabia
www.ports.gov.sa



St-Joseph Women's Hospital
Tampa, Florida
www.sjbhealth.org
Eng: Smith, Seckman, Reid Engineering



Millennium Hilton
New-York City, NY, U.S.A
www.hilton.com



Le M Lorraine
Lorraine, Quebec, Canada
www.lemlorraine.com



Morton Plant North Bay Hospital
New Port Richey, Florida
www.mortonplant.com
Eng : IC Thomasson Association Incorporated



Lowney
Montréal, Quebec, Canada
<http://lelowney.prevel.ca>

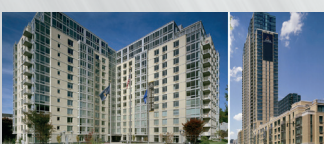

Sheepshead Residential Tower
Brooklyn, New York City, U.S.A.
<http://www.sheepsheadbites.com>

Sales and Service:

Quebec, Canada
Tel. : 450 621-2995
Fax : 450 621-4995

Toronto, Canada
Tel. : 1 647 544-2995

Lake Worth
Florida, USA
33467-5749

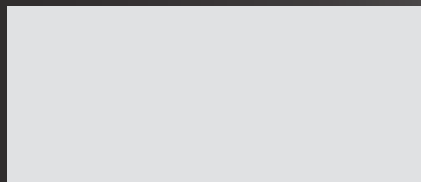

www.flofab.com

SERVICE 24/7 : parts@flofab.com

