

# Double Suction Split Case Fire Pump

**Series  
4800 & 4900  
(New Generation)**

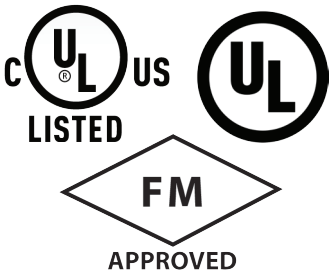

[www.flofab.com](http://www.flofab.com)

001-cat-2016-4000f

# TABLE OF CONTENT

<b>CONSTRUCTION.....</b>	<b>2</b>
<b>PRODUCT FEATURES.....</b>	<b>3</b>
<b>TYPICAL SPECIFICATIONS.....</b>	<b>4</b>
<b>FIRE PUMP MOTORS - ODP.....</b>	<b>5</b>
<b>THREE PHASE, ODP, FOOT MOUNTED.....</b>	<b>6</b>
<b>THREE PHASE, ODP FOOTLESS, CLOSED-COUPLED PUMP.....</b>	<b>7</b>
<b>DIAGRAMS.....</b>	<b>8</b>
<b>PRODUCT CHARACTERISTICS.....</b>	<b>9</b>
<b>PERFORMANCE CURVES.....</b>	<b>10</b>

## HISTORY

Flo Fab was established in 1981 by Denis Gauvreau who created and developed the products line and constantly being perfected by Marc Gauvreau, as well as by a team of professional engineers and designers. It's a combination of existing designs from several renowned products and the innovative ideas of a new generation professionals.

Through the years, Flo Fab has acquired several companies and service entities including : AQUA-PROFAB (ASME Tanks manufacturer), MÉNARD, LÉONARD ÉLECTRIQUE, PMA. , Furthermore Flo Fab purchased equipment, fabrication designs and patterns from IDEALCO, a manufacturer of shell and tube type heat exchangers.

The after sales services, sales, engineering, R&D, production, quality control, accounting and administration departments of all the above companies share the same location.

In December 2014, Marc Gauvreau, son of the founder, acquired all shares of The company. Flo Fab and is constantly investing in new state of the art innovations new product like the XRI series and Prefab Skid for Hydronic Heating & cooling system, pumping systems. This has allowed Flo Fab to retain competent and experienced staff of professionals with varied and specialized abilities that constantly work on improving our existing products and add new engineered solutions that exceeding customer's expectations .

Flo Fab has grown quite rapidly and now proudly offers of a wide range of products available directly from one manufacturer. This includes pumps & pump packages, tanks, heat exchangers & hydronic accessories. This allows each project stakeholders to enjoy economical savings, peace of mind, best value for their investment and optimized total cost of ownership.





# SERIES 4800/4900 - FIRE PUMP





## ● Product Features

### Series 4800/4900 H (New Generation)

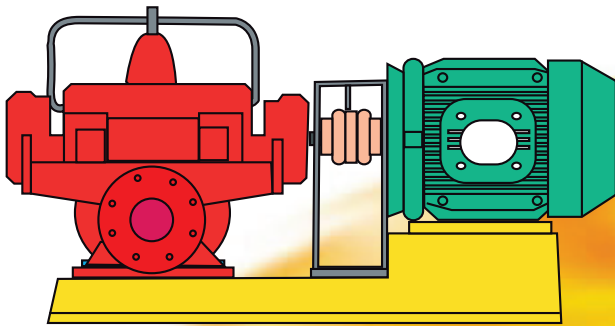

#### Features and Benefits

**Application:** The series 4800 are double suction split case type and are most commonly applied for fire protection systems or other industrial applications.

**Features and Benefits:**

The axially split volute casing of this series makes this pump especially easy to service. Inspection of the rotor assembly is possible without removing the pump from the piping. When assembling, the locking of the upper part takes place automatically.

**Innovative Casing:** Hydraulically optimized casing in several material variants.

**Seal Appropriate for the Application:** Mechanical seals or asbestos-free gland packing suitable to the application.

**Low Vibrations:** Small bearing distance and short rotors for low vibration operation.

Variable Components: Same sealing and bearing housing, bearings and seals on both sides.

**Power Impeller:** Minimum axial thrust for best hydraulic values.

**Long-Life Bearings:** Covered, grease lubricated rolling element bearings for long operating life.

#### Operating Data

**Sizes:** (DN) 80 to 350mm (3" to 14")

**Flow:** (Q) from 500 USGPM to 5000 USGPM

**Head:** (H) up to 600 PSI(4136 kPa), up to 190m (625 ft)

**Maximum Operating Pressure:** (t) up to 1204 kPa/175 PSI, 1720kPa/250 PSI

**Maximum Operating Temperature:** (P) up to 225°F/107°C, 250°F/120°C

**Speed:** (n) up to 3450 RPM



# • Typical Specifications

### GENERAL

The pumps furnished for fireprotection service shall be supplied with the specified drivers, controls and pump accessory items by the pump manufacturer. The pump, driver and control shall be

- Underwriters Laboratories (UL) Listed
- Factory Mutual Research Corporation (FM) Approved
- Underwriters Laboratories-Canada (ULC) Listed for fire protection service. The pumping equipment shall be installed as recommended in the National Fire Protection Association (NFPA) Pamphlet 20, Standard for the Installation of Centrifugal Fire Pumps. The fire pump shall be designed to deliver \_\_\_\_\_ U.S. gallons per minute (USGpm) at a total differential pressure of \_\_\_\_\_ psiG. The fire pump shall also be capable of delivering not less than 150% of rated flow at not less than 65% rated head. Flo Fab Pump model \_\_\_\_\_ shall be furnished with driver, controllers and accessories as detailed in this specification. Pump manufacturer shall have unit responsibility for the proper operation of the complete unit assembly as indicated by field acceptance tests.

### MANUFACTURER'S FACTORY TESTS

Each individual pump shall be hydrostatically tested and run tested prior to shipment. The pump shall be hydrostatically tested at a pressure of not less than one and one-half times the no flow (shut off) head of the pump's maximum diameter impeller plus the maximum allowable suction head but in no case less than 250 psig

### FIELD ACCEPTANCE TEST

A field acceptance performance test shall be conducted upon completion of pump installation. The test shall be made by flowing water through calibrated nozzles, approved flow meters or other such accurate devices as may be selected by the authority having jurisdiction. The test shall be conducted as recommended in NFPA Pamphlet 20 by the

- installing contractor
- the owner
- the owner's representative
- (other) \_\_\_\_\_

in the presence of the authority having jurisdiction and with that authority's final approval and acceptance. Failure to submit documentation of factory and field tests will be just cause for equipment rejection.

### HORIZONTAL CENTRIFUGAL PUMPS

The fire pump shall be of horizontal centrifugal (single stage) (multistage) construction specifically labeled for fire service and shall be a Flo Fab Pump model \_\_\_\_\_

The pump shall be connected to the (fire standpipe) (fire sprinkler) (underground fire main) system. The suction supply for the fire pump shall be from a (public service water main) (elevated storage tank) (ground storage tank) (underground reservoir) at a maximum pressure of \_\_\_\_\_ pounds per square inch (psig) and a minimum pressure of \_\_\_\_\_ psig. The pump casing

shall be cast iron with \_\_\_\_\_ inch 125 pound ANSI rated suction and \_\_\_\_\_ inch(125)(250) pound ANSI rated discharge flanges machined to American National Standards Institute (ANSI) dimensions.

### ELECTRIC MOTORS

The pump driver shall be horizontal foot mounted ball bearing induction motor rated \_\_\_\_\_ horsepower, 3 phase, (50)(60) Hertz with open ODP and TEFC NEMA \_\_\_\_\_ enclosure for operation on \_\_\_\_\_ volt phase service. The motor locked rotor current shall not exceed the values stated in NFPA Pamphlet 20. The motor shall be mounted on a steel base common to the pump and shall be connected to the pump with a flexible coupling protected by a suitable guard. The fire pump manufacturer shall accurately align the pump and motor shafts prior to shipment. After field installation but prior to grouting the base, a millwright or similarly qualified person shall check and verify or correct the shaft alignment.

### ELECTRIC MOTOR CONTROLLERS

The automatic electric motor controller shall be (UL listed)(FM approved) specifically for fire pump service. The controller shall be designed for full voltage part winding primary resistance reduced voltage

- wye-delta open transition
- wye-delta closed transition
- auto-transformer
- solid state (soft start)

type starting. The controller shall be rated for the horsepower specified in this specification's electric motors section. The controller shall be capable of interrupting a short circuit current at least equal to the available short circuit current in the controller supply circuit.

This fire pump controller installation requires an withstand rating of not less than amps RMS symmetrical at an operating voltage of volts. The controller shall be:

- floor or wall mounted for electrical connection to the motor by the equipment installer.
- mounted on a common base with the fire pump and wired to the motor by the pump manufacturer.

### FITTINGS

The pump manufacturer shall furnish piping accessory items for the pump installation which will adapt the pump connections to the fire protection system and test connection as follows.

Fittings subjected to pump discharge pressure shall be ANSI (125)(250) pound rating. Fittings subjected to suction pressure shall be ANSI 125 pound rating.

- eccentric tapered suction reducer
- concentric tapered discharge increaser
- hose valve test header
- hose valves with caps and chains
- pump casing relief valve
- automatic air release valve
- hose valve head drain valve
- suction and discharge pressure gauges

Subject to change without notice.

Additional accessories required when pump is engine or steam turbine driven:

- main relief valve:
- direct acting (spring actuated)
- pilot operated (hydraulically actuated)
- relief valve overflow cone, enclosed type
- discharge tee with elbow (for mounting relief valve)

### DIESEL ENGINES

The pump driver shall be a horizontal shaft type internal combustion engine Model manufactured by: rated at rpm, clockwise rotation viewed from the end opposite the pump. The engine shall be provided by the pump manufacturer with, at a minimum, the following accessories for automatic operation.

- cooling waterlines, pressure regulator, strainer, bypass lines and necessary fittings for engine cooling system, pre-piped and factory mounted.
- flexible exhaust connector
- residential exhaust silencer
- engine jacket water heater, factory installed.
- one set dual batteries, lead acid storage type.
- fuel system as recommended in NFPA Pamphlet 20
- fuel storage tank sized to provide a minimum supply of one gallon of fuel per engine maximum rated horsepower plus 5% for sump area plus 5% for expansion area. The tank shall be furnished (with)(without) legs for floor mounting and with a direct reading level gauge. Fuel tank shall (single wall)(dual wall) UL listed; single wall non-listed
- The engine shall be run tested with the pump by the pump manufacturer prior to shipment.

### ENGINE CONTROLLERS

The automatic engine controller shall be (UL listed)(FM approved) specifically for fire pump service. The controller must be capable of performing or contain the following features: Built in battery charger

- time clock for weekly automatic test
- system pressure recorder
- timing relay for automatic stop
- power failure start
- low fuel level switch
- pump room alarm audible and visual signals
- The controller shall be wired to the corresponding engine function terminals and shall be mounted on a common base with the engine and pump. A complete running test of the base mounted controller, engine and pump shall be performed by the pump manufacturer prior to shipment.
- The engine controller shall be floor mounted for electrical connection to the engine by the





## Fire Pump Motors ODP, 10 thru 300 HP

### APPLICATIONS:

Baldor•Reliance Fire pump motors are designed for use on fire pumps installed per NFPA-20. These Open Drip Proof motors are for use in relatively clean and dry environments.

### AVAILABLE STOCK RATINGS:

- Foot mounted 10-300 Hp
- Closed Coupled Pump 10-100 Hp
- 2 & 4 pole designs
- 50/60 Hz
- 230/460V, 460V and 200/400V

### ELECTRICAL FEATURES:

- Class F insulation system
- 1.15 service factor
- 40°C ambient continuous
- NEMA Design B, 60 Hz
- Fire Pump motors are not recommended for use with variable frequency drives.
- UL file E481231



### MECHANICAL FEATURES:

- IP22 / IP23
- 213T-404TS Rolled steel construction
- 444TS-445TS Cast Iron construction
- Exterior red paint RAL3002
- Meets NEMA MG1

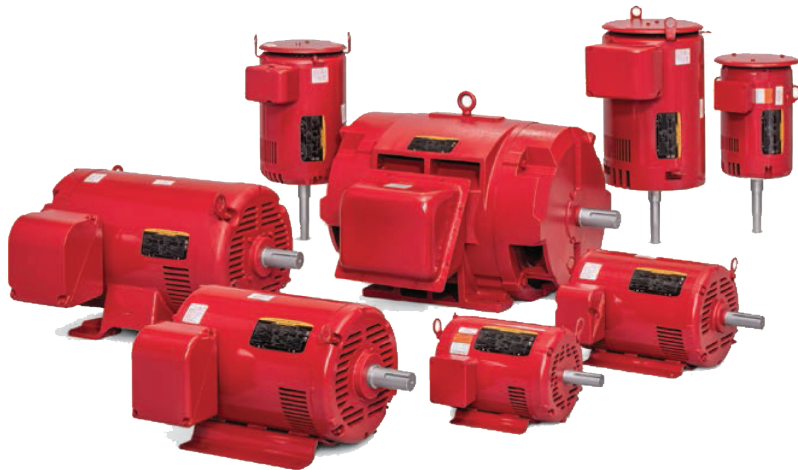



# SERIES 4800/4900 - FIRE PUMP

THREE PHASE, ODP, FOOT MOUNTED



Hp	RPM	NEMA Frame	Catalog Number	List Price	Mult. Sym.	"C" Dim.	Aprx. Wt. (lb)	Full Load Efficiency	Voltage	Full Load Amps
<b>230/460 &amp; 460 Volts</b>										
10	3600	213T	FPM3312T	1,322	FP	16.32	121	88.5	230/460	12
	1800	215T	FPM3313T	1,488	FP	16.32	115	89.5	230/460	13.4
15	3600	215T	FPM3314T	1,720	FP	16.32	131	89.5	230/460	17.7
	1800	254T	FPM2513T	1,967	FP	22.25	213	91	230/460	17.5
20	3600	254T	FPM2514T	2,051	FP	22.25	145	90.2	230/460	23
	1800	256T	FPM2515T	2,113	FP	21.69	225	91	230/460	24
25	3600	256T	FPM2516T	2,293	FP	21.69	210	91	230/460	29
	1800	284TS	FPM2531TS	2,548	FP	23.56	236	91.7	230/460	29
30	3600	284TS	FPM2534T	2,647	FP	22.06	235	91	230/460	35
	1800	286TS	FPM2535TS	3,162	FP	23.69	340	92.4	230/460	36
40	3600	286TS	FPM2538T	3,363	FP	23.56	263	91.7	230/460	45
	1800	324TS	FPM2539TS	3,515	FP	24.69	375	93	230/460	49
50	3600	324TS	FPM2542T	3,835	FP	24.69	331	92.4	230/460	58
	1800	326TS	FPM2543TS	3,882	FP	25.69	385	93	230/460	60
60	3600	326TS	FPM2546T	4,677	FP	25.69	385	93	230/460	68
	1800	364TS	FPM2547TS	4,976	FP	25.81	480	93.6	230/460	72
75	3600	364TS	FPM2549T	6,378	FP	25.81	485	93	230/460	84
	1800	365TS	FPM2551TS	5,598	FP	27.81	570	94.1	230/460	87
100	3600	365TS	FPM2550T	6,922	FP	26.81	523	93	230/460	113
	1800	404TS	FPM2555TS	8,407	FP	31.85	597	94.1	230/460	117
125	3600	404TS	FPM2554T-4	9,635	FP	31.85	660	93.6	460	138
	1800	405TS	FPM2559TS-4	9,919	FP	33.60	590	94.5	460	145
150	3600	405TS	FPM2556T-4	11,830	FP	31.85	925	93.6	460	164
	1800	444TS	FPM2558TS-4	11,560	FP	35.88	1579	95	460	167
200	3600	444TS	FPM2562T-4	15,174	FP	35.88	1449	94.5	460	232
	1800	445TS	FPM2563TS-4	14,220	FP	35.88	1718	95	460	224
250	3600	445TS	FPM2565T-4	15,975	FP	35.88	1737	94.5	460	288
	1800	445TS	FPM2566TS-4	16,184	FP	35.88	1844	95.4	460	272
300	3600	445TS	FPM2568T-4	23,699	FP	35.88	1697	95	460	339
<b>200/400 Volts</b>										
25	3600	256T	FPM2516T-2/4	2,293	FP	21.69	210	91	200/400	34
	1800	284TS	FPM2531TS-2/4	2,548	FP	23.56	236	91.7	200/400	34
30	3600	284TS	FPM2534T-2/4	2,647	FP	22.06	235	91	200/400	40
	1800	286TS	FPM2535TS-2/4	3,162	FP	23.69	340	92.4	200/400	41
40	3600	286TS	FPM2538T-2/4	3,363	FP	23.56	263	91.7	200/400	52
	1800	324TS	FPM2539TS-2/4	3,515	FP	24.69	375	93	200/400	56
50	3600	324TS	FPM2542T-2/4	3,835	FP	24.69	331	92.4	200/400	67
	1800	326TS	FPM2543TS-2/4	3,882	FP	25.69	385	93	200/400	70
60	3600	326TS	FPM2546T-2/4	4,677	FP	25.69	385	93	200/400	78
	1800	364TS	FPM2547TS-2/4	4,976	FP	25.81	480	93.6	200/400	83
75	3600	364TS	FPM2549T-2/4	6,378	FP	25.81	485	93	200/400	96
	1800	365TS	FPM2551TS-2/4	5,598	FP	27.81	570	94.1	200/400	100
100	3600	365TS	FPM2550T-2/4	6,922	FP	26.81	523	93	200/400	130
	1800	404TS	FPM2555TS-2/4	8,407	FP	31.85	597	94.1	200/400	135

Cast Iron Frame



# SERIES 4800/4900 - FIRE PUMP

THREE PHASE, ODP, FOOTLESS, CLOSE-COUPLED PUMP



Hp	RPM	NEMA Frame	Catalog Number	List Price	Mult. Sym.	"C" Dim.	Aprx. Wt. (lb)	Full Load Efficiency	Voltage	Full Load Amps
<b>230/460 Volts</b>										
10	3600	213JP	VJPFPM3312T	1,397	FP	24.41	121	88.5	230/460	12
	1800	215JP	VJPFPM3313T	1,559	FP	24.41	117	89.5	230/460	13.4
15	3600	215JP	VJPFPM3314T	1,795	FP	24.41	131	89.5	230/460	17.7
	1800	254JP	VJPFPM2513T	2,230	FP	28.07	220	91	230/460	17.5
20	3600	254JP	VJPFPM2514T	2,389	FP	27.66	145	90.2	230/460	23
	1800	256JP	VJPFPM2515T	2,497	FP	28.07	231	91	230/460	24
25	3600	256JP	VJPFPM2516T	2,745	FP	28.07	221	91	230/460	29
	1800	284JP	VJPFPM2531T	3,062	FP	31.44	272	91.7	230/460	29
30	3600	284JP	VJPFPM2534T	3,250	FP	29.23	235	91	230/460	35
	1800	286JP	VJPFPM2535T	3,758	FP	29.25	375	92.4	230/460	36
40	3600	286JP	VJPFPM2538T	3,885	FP	31.44	263	91.7	230/460	45
	1800	324JP	VJPFPM2539T	4,519	FP	31.13	375	93	230/460	49
50	3600	324JP	VJPFPM2542T	4,841	FP	31.13	331	92.4	230/460	58
	1800	326JP	VJPFPM2543T	5,030	FP	32.13	378	93	230/460	60
60	3600	326JP	VJPFPM2546T	5,730	FP	32.13	385	93	230/460	68
	1800	364JP	VJPFPM2547T	6,232	FP	32.50	480	93.6	230/460	72
75	3600	364JP	VJPFPM2549T	7,728	FP	32.50	472	93	230/460	84
	1800	365JP	VJPFPM2551T	7,275	FP	34.50	565	94.1	230/460	87
100	3600	365JP	VJPFPM2550T	8,245	FP	33.50	523	93	230/460	113
<b>200/400 Volts</b>										
10	3600	213JP	VJPFPM3312T-2/4	1,397	FP	24.41	121	88.5	200/400	12
15	3600	215JP	VJPFPM3314T-2/4	1,795	FP	24.41	131	89.5	200/400	20.4
20	3600	254JP	VJPFPM2514T-2/4	2,389	FP	27.66	145	90.2	200/400	26.5
25	3600	256JP	VJPFPM2516T-2/4	2,745	FP	28.07	221	91	200/400	34
30	3600	284JP	VJPFPM2534T-2/4	3,250	FP	29.23	235	91	200/400	40
40	3600	286JP	VJPFPM2538T-2/4	3,885	FP	31.44	263	91.7	200/400	52
50	3600	324JP	VJPFPM2542T-2/4	4,841	FP	31.13	331	92.4	200/400	67
60	3600	326JP	VJPFPM2546T-2/4	5,730	FP	32.13	385	93	200/400	78
75	3600	364JP	VJPFPM2549T-2/4	7,728	FP	32.50	472	93	200/400	96
100	3600	365JP	VJPFPM2550T-2/4	8,245	FP	33.50	523	93	200/400	130





# SERIES 4800/4900 - FIRE PUMP

**CD0005**  
(BELOW 20 Hp)

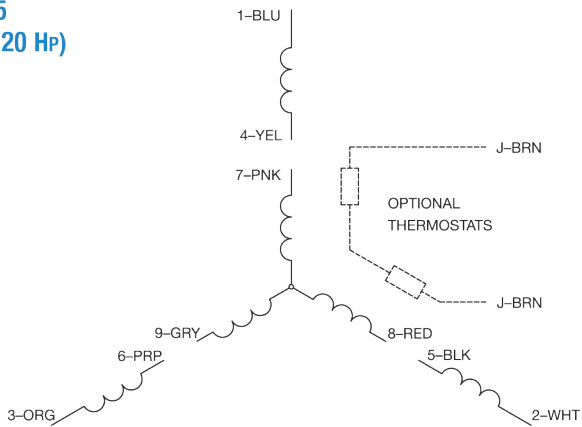

**LOW VOLTAGE**  
(2Y)



LINE

**HIGH VOLTAGE**  
(1Y)



LINE

**CD0104**  
(20 Hp THRU 100 Hp)

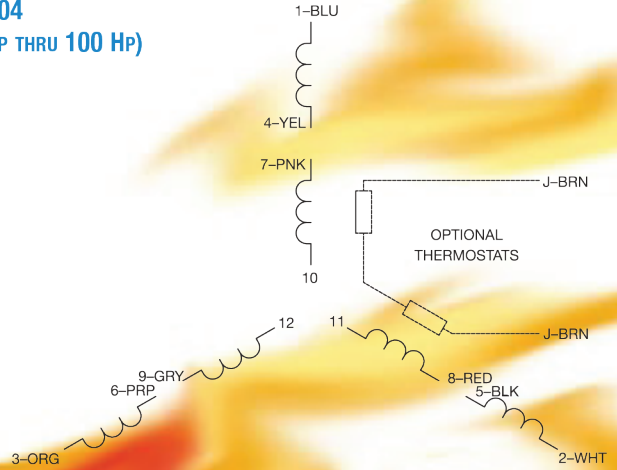

**LOW VOLTAGE**  
START (2Y) RUN (2D)

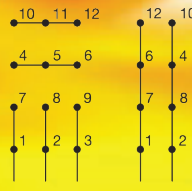

LINE

**HIGH VOLTAGE**  
START (1Y) RUN (1D)

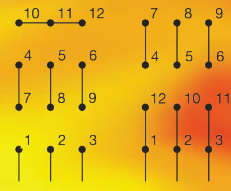

LINE

**CD1480**  
(125 Hp & LARGER)

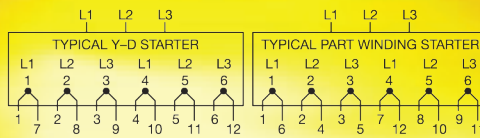
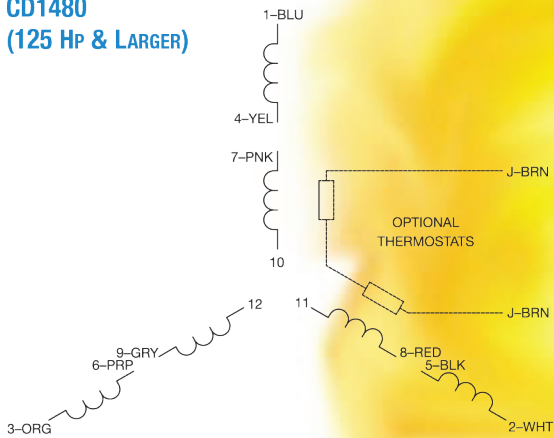

**Y - D START**

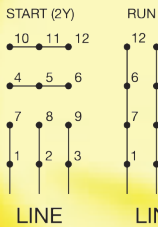

LINE

**PART WIND START**

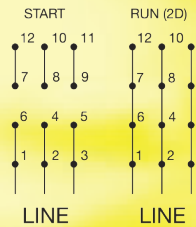

LINE

**NOTES:**

(all diagrams)

1. INTERCHANGE ANY TWO LINE LEADS TO REVERSE ROTATION.
2. OPTIONAL THERMOSTATS ARE PROVIDED WHEN SPECIFIED.
3. ACTUAL NUMBER OF INTERNAL PARALLEL CIRCUITS MAY BE A MULTIPLE OF THOSE SHOWN ABOVE.
4. LEAD COLORS ARE OPTIONAL. LEADS MUST ALWAYS BE NUMBERED AS SHOWN.





**Product Characteristics**

**UL/ FM Parameter Table Electric Motor Driven Pump**

No.	Flo Fab Model	Size inches	Rated Capacity (usgpm)	Total Head Range (m)	Total Head Range (psi)	Speed (rpm)	Impeller Max./Min.dia. (mm)	Shut off Pressure (Max Impeller) (m)	Shut off Pressure (Max Impeller) (psi)
1	5X3X125-80-350	5X3	500	136/102	193-145	2980	300/270	137	195
			750	130/89	185-126		300/270		
2	6X4X150-100-320	6X4	1000	126/85	179-121	2980	300/255	134	190
3	8X5X200-125-300	8X5	1250	126/77	179-109		300/240	132	187
4*	8X5X200-125-380	8x5	1250	128/105	185-126	2980	380/310	146	197
5	8X6X200-150-460	8X6	1500	125/81	178-115	1800	460/380	129	183
			2000	121/86	172-122		460/395		
6	10X8X250-200-430	10X8	2500	92	131	1800	425	98	139
			3000	132/85	187-121		490/400		
7	12X10X300-250-490	12X10	3500	131/86	186-122	1800	490/410	138	196
			4000	129/82	183-116		490/410		

**UL/ FM Parameter Table Diesel Engine Driven Pump**

No.	Flo Fab Model	Size inches	Rated Capacity (usgpm)	Total Head Range (m)	Total Head Range (psi)	Speed (rpm)	Impeller Max./Min.dia. (mm)	Shut off Pressure (Max Impeller) (m)	Shut off Pressure (Max Impeller) (psi)
1	5X3X125-80-350	5X3	500	130/82	185-116	2650	330/270	133	189
			750	122/84	173-119		330/290		
2	6X4X150-100-320	6X4	1000	122/70	173-99	2650	325/265	126	179
3	8X5X200-125-300	8X5	1250	126/177	179-109		300/240	132	187
4	8X5X200-125-380	8X5	1250	123/82	175-116	2200	385/325	126	179
5	8X6X200-150-460	8X6	1500	125/81	178-115	1800	460/380	129	183
			2000	121/86	172-122		460/395		
6	10X8X250-200-430	10X8	2500	127/88	180-125	2100	425/360	135	192
			3000	132/86	187-121		490/400		
7	12X10X300-250-490	12X10	3500	131/86	186-122	1800	490/410	138	196
			4000	129/82	183-116		490/410		

Casing: Ductile cast iron  
 Impeller: SS304  
 Shaft: 40CrNi2Mo (AISI4340)  
 Shaft Sleeve: SS304  
 Seal ring: Bronze  
 Seal: Packing Gland

PARTS LIST		
ITEM	QTY	DESCRIPTION
1	2	FIRE PUMP SPLIT CASE DOUBLE SUCTION MODEL4900 8x6
3	2	MOTOR 200HP/480V/3/1800RPM
6	2	PRESSURE RELIEF VALVE Model: 2050B-1KG1 Angle
7	2	WAFER CHECK VALVES 8" - CLASS-300
8	2	MOTOR COUPLING
10	2	GATE-VALVE 8" - CLASS-300
12	6	BUTTERFLY VALVE_WHEEL 8" CLASS 300
14	2	GERAND FLOW-METER MODEL K-1500-8
17	2	FIRE PUMP CONTROLLER GPS4-GPU
18	2	JOCKEY PUMP CONTROLLER JPS
20	2	JOCKEY PUMP MODEL PSM-03-15
21	2	MOTOR 3HP/480/3/3500RPM
23	2	AIR VENT - 3/4" NPT
25	2	BRASS CHECK VALVE - 1" NPT
26	4	Ball valve 1"

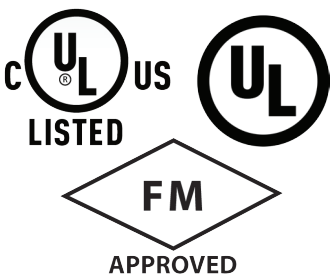
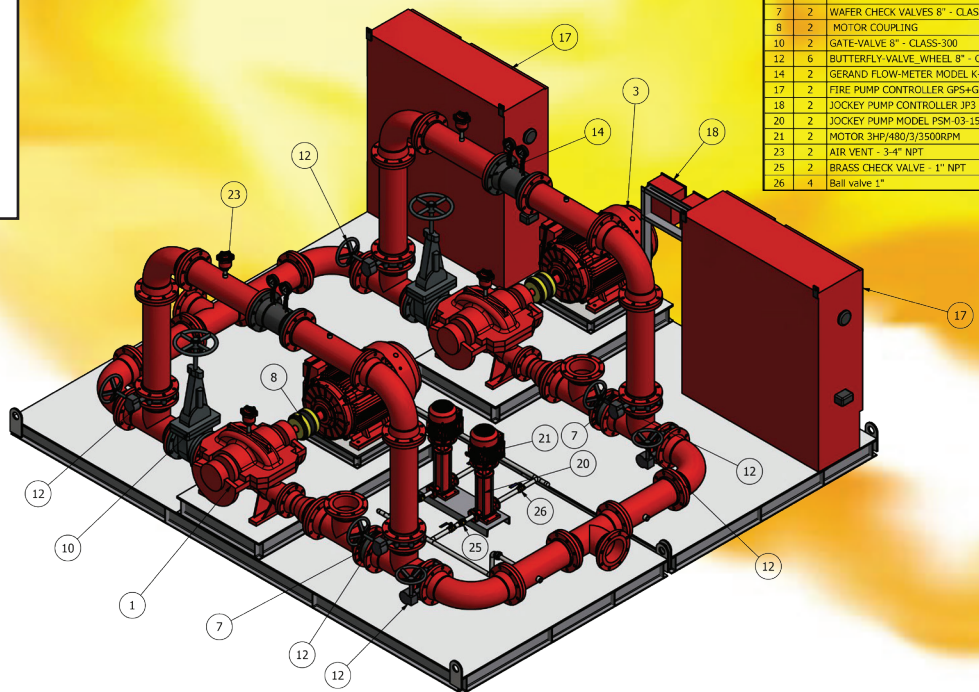



● **Performance Curves**  
**Series 4800**  
**& 4900 (New Generation)**

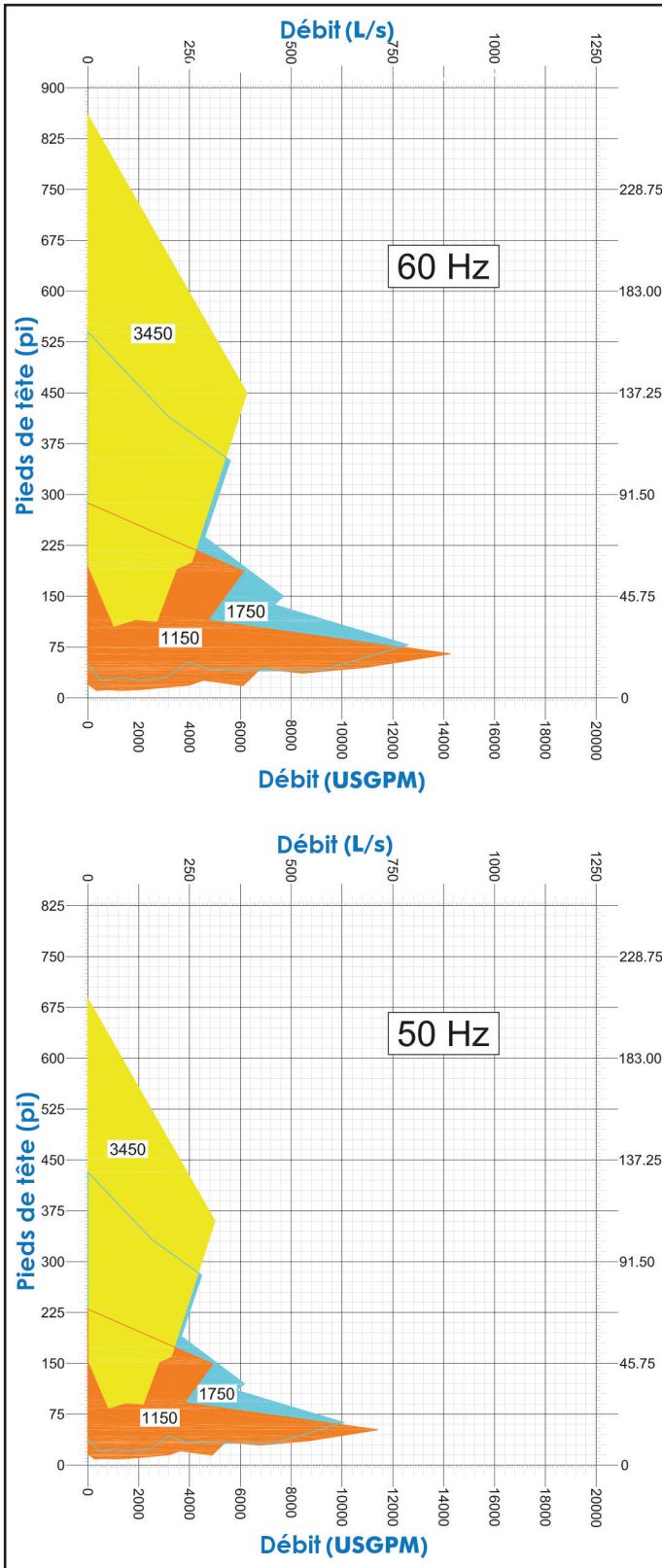

**DIRECTION OF ROTATION**

The rotation of a horizontal split case pump is determined by viewing the pump from the driver end in the direction of the arrow. The rotation fixes the position of the suction and discharge flanges.

For pumps having dual drive such as engine and electric motor, the rotation is specified from the engine end of the unit.

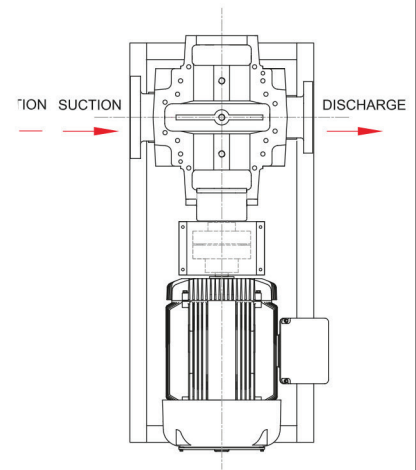

LEFT HAND OR COUNTER-CLOCKWISE ROTATION



We are proud supplier for the following completed and on going projects :

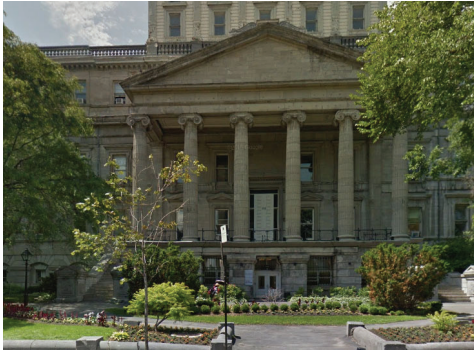

**Montreal City**  
85 Notre-Dame Street E,  
Montreal, QC, CA



**College of Maisonneuve**  
3800 Sherbrooke Street E,  
Montreal, QC, CA

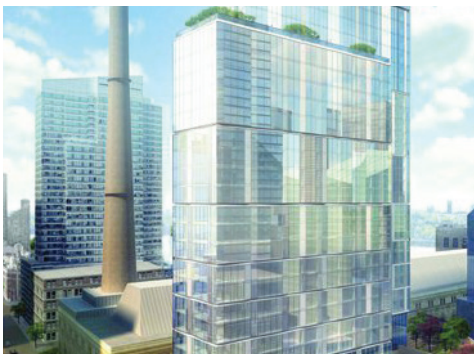

**Riverside Center Building 5**  
1 West End Avenue  
NY, US

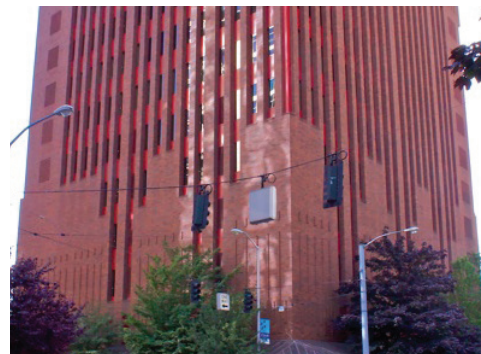

**Building 2101**  
2101 2nd Avenue, Seattle,  
Washington, Belltown



## Sales and Service:

Quebec, Canada  
Tel. : (450) 621-2995  
Fax : (450) 621-4995

Lake Worth  
Florida, USA  
33467-5749

Toronto, Canada  
Tel. : +1 (647) 544-2995

[www.flofab.com](http://www.flofab.com)

SERVICE 24/7 : [parts@flofab.com](mailto:parts@flofab.com)

